



E9\*65R00/10\*6256\*01

Página / Page 1/2



COMUNICACIÓN / COMMUNICATION:

Concerniente a <sup>(1)</sup>: ~~LA CONCESIÓN DE HOMOLOGACIÓN  
LA EXTENSIÓN DE HOMOLOGACIÓN  
LA DENEGACIÓN DE HOMOLOGACIÓN  
LA RETIRADA DE HOMOLOGACIÓN  
EL CESE DEFINITIVO DE PRODUCCIÓN~~  
Concerning <sup>(1)</sup>: ~~APPROVAL GRANTED  
APPROVAL EXTENDED  
APPROVAL REFUSED  
APPROVAL WITHDRAWN  
PRODUCTION DEFINITELY DISCONTINUED~~

de un tipo de luz especial de aviso para automóviles en aplicación del Reglamento N° 65.  
*of a type of special warning lamp for motor vehicles, pursuant to Regulation No.65.*

N° de homologación / Approval No.: E9\*65R00/10\*6256\*01

Extensión N° / Extension No.: 01

- Luz especial de aviso / ~~rotativa~~ / luz estacionaria intermitente / ~~luz direccional intermitente~~ / barra completa / ~~media barra~~ / azul / ~~amarillo auto~~ / ~~rojo~~ <sup>(1)</sup> / *Special warning lamp / ~~rotating~~ / stationary flashing lamp / ~~directional flashing lamp~~ / complete bar / ~~half bar~~ / blue / ~~amber~~ / red <sup>(1)</sup>*
- Luz especial de aviso con un / ~~dos~~ nivel(es) de intensidad <sup>(1)</sup> / *Special warning lamp has one / ~~two~~ level(s) of intensity <sup>(1)</sup>*  
Luz especial de aviso formada por --- unidades separadas / *Special warning lamp consists of --- separate units*
- Para las luces especiales de aviso con dos niveles de intensidad, sistema empleado para obtener intensidad reforzada de día / *For special warning lamps having two levels of intensity, indicate the system used to obtain increased intensity at daytime: ---*
- Fuente de luz utilizada / *Used light source:*
  - categoría de lámpara de incandescencia / *category of filament lamp:* sí / ~~yes~~ - no / ~~no~~ <sup>(1)</sup>
  - lámpara de descarga de gas / *gas discharge light source:* sí / ~~yes~~ - no / ~~no~~ <sup>(1)</sup>
  - LED: sí / ~~yes~~ - ~~no~~ / ~~no~~ <sup>(1)</sup>
  - Módulo de fuente de luz / *Light source module:* sí / ~~yes~~ - ~~no~~ / ~~no~~ <sup>(1)</sup>  
Código específico de identificación del módulo de fuente de luz / *Light source module specific identification code: ---*
- Tensión nominal de la luz especial de aviso / *Rated voltage of special warning lamp:* 12V/24V
- Marca o denominación comercial / *Trade name or mark:* Sanmak

Tipo / Type: SM7302-B

<sup>(1)</sup> Táchese lo que no proceda / *Strike out what does not apply*



E9\*65R00/10\*6256\*01

Página / Page 2/2



7. Nombre y dirección del fabricante / *Manufacturer's name and address:*  
Sanmak Lighting Co., Ltd.  
Block 3, Chuangfu Industry Zone, Lihe Rd., Nanhai District, Foshan, China
8. En su caso, nombre y dirección del representante del fabricante / *If applicable, name and address of manufacturer's representative:* ---
9. Dispositivo presentado a homologación el / *Submitted for approval on:* 22/04/2019
10. Servicio técnico encargado de los ensayos de homologación / *Technical service responsible for conducting approval test:* IDIADA
11. Fecha del informe emitido por dicho servicio / *Date of report issued by that service:* 26/04/2019
12. Número del informe emitido por dicho servicio / *Number of report issued by that service:* CN18120395, **CN19040751**
13. Se ~~concede~~/~~deniega~~/extiende/~~retira~~ la homologación <sup>(1)</sup> / ~~Approval granted/refused/extended/withdrawn~~ <sup>(1)</sup>
14. Motivos de la extensión (en su caso) / *Reason(s) of extension (if applicable):* Añadir nuevas variantes / *Add new variants.*
15. Lugar / *Place:* Madrid
16. Fecha / *Date:* Ver firma electrónica / *See electronic signature*
17. Firma / *Signature:*  
  
EL SUBDIRECTOR GENERAL DE CALIDAD Y SEGURIDAD INDUSTRIAL  
Resolución P.D. del DIRECTOR GENERAL DE INDUSTRIA Y DE LA PYME de 25-10-2012
18. Se adjunta la lista de apartados que constituyen el expediente de homologación depositado en el servicio administrativo que ha concedido la homologación y que pueden ser obtenidos a petición. / *The list of documents deposited with the Administrative Service which has granted approval is annexed to this communication and may be obtained on request.*
  - Informe del ensayo / *Test report*
  - Documentación suministrada por el fabricante / *Documentation supplied by the manufacturer*

<sup>(1)</sup> Táchese lo que no proceda / *Strike out what does not apply*

**INFORME N° / REPORT No. CN19040751**

RELATIVO A LA HOMOLOGACIÓN DE LUCES ESPECIALES DE AVISO PARA AUTOMÓVILES  
SEGÚN EL REGLAMENTO ECE 65.00 / *CONCERNING THE APPROVAL OF SPECIAL WARNING LIGHTS  
FOR POWER-DRIVEN VEHICLES ACCORDING TO REGULATION ECE 65.00*

**EXTENSIÓN / EXTENSION I**

Nombre y dirección del fabricante /  
*Manufacturer's name and address* : Sanmak Lighting Co., Ltd.  
Block 3, Chuangfu Industry Zone, Lihe Rd., Nanhai District,  
Foshan, China

Marca comercial / *Trade mark* : Sanmak

Tipo / *Type* : SM7302-B

Lugar y fecha de emisión del informe /  
*Place and date of test report issue* : L'Albornar, Santa Oliva (Tarragona)  
26/04/2019

**CONCLUSIONES / CONCLUSIONS:** Las modificaciones introducidas, que se detallan en el Anexo a este Informe, son objeto de extensión de homologación respecto al tipo homologado por este servicio (Informe N° CN18120395) y **CUMPLE** con las prescripciones uniformes relativas a la homologación de luces especiales de aviso para automóviles en aplicación del Reglamento N° 65.00 ECE / *Modifications introduced, as detailed in the Annex attached to this report, are extension of homologation with respect to formerly certified type performed by this technical department (Test Report No. CN18120395) and FULFILLS the prescriptions with regard to the special warning lights in application of Regulation No.65.00 ECE*

Realizado por / *Performed by:*

Joan Fonts Sala  
INGENIERO DE ENSAYOS  
*TEST ENGINEER*

V. B° / *Revised by:*

Lluís Sans Gomis  
JEFE DE DEPARTAMENTO  
*DEPARTMENT MANAGER*

\* LOS RESULTADOS PRESENTADOS SE REFIEREN ÚNICAMENTE A LA MUESTRA ENSAYADA.  
*THE PRESENTED RESULTS REFER ONLY TO THE TESTED SAMPLE*

\* QUEDA TERMINANTEMENTE PROHIBIDA LA REPRODUCCIÓN PARCIAL DE ESTE INFORME SIN PERMISO EXPRESO DE IDIADA.  
*THE PARTIAL REPRODUCTION OF THIS REPORT WITHOUT THE PERMISSION OF IDIADA IS COMPLETELY FORBIDDEN*

**ANEXO AL INFORME  
ANNEX TO THE REPORT**

RELATIVO A LA HOMOLOGACIÓN DE LUCES ESPECIALES DE AVISO PARA AUTOMÓVILES  
SEGÚN EL REGLAMENTO ECE 65.00 / *CONCERNING THE APPROVAL OF SPECIAL WARNING LIGHTS  
FOR POWER-DRIVEN VEHICLES ACCORDING TO REGULATION ECE 65.00*

Nombre y dirección del fabricante /  
*Manufacturer's name and address* : Sanmak Lighting Co., Ltd.  
Block 3, Chuangfu Industry Zone, Lihe Rd., Nanhai District,  
Foshan, China

Marca comercial / *Trade mark* : Sanmak

Tipo / *Type* : SM7302-B

Variantes / *Variants* : SM7302-B-3, SM7302-B-4, SM7302-B-5, SM7303-B-1

Identificación de las muestras /  
*Sample identification* : CN19040751

Luz especial de aviso /  
*Special warning lamp* \* : ~~Rotativa / Rotating~~  
Luz estacionaria intermitente / *Stationary flashing lamp*  
~~Luz direccional intermitente / Directional flashing lamp~~  
Barra completa / *Complete bar*  
~~Media barra / Half bar~~

Categoría / *Category* : T

Color / *Colour* : Azul / *Blue*

Clase / *Class* \* : 1 / 2

Patrones de destello / *Flash patterns* : Un pulso por flash / *One pulse in one flash*

Fuente luminosa / *Light source* : LED

Módulo de fuente luminosa /  
*Light source module* \* : Sí / *Yes* — ~~No / No~~

Código específico de identificación del módulo de fuente luminosa /  
*Light source module specific identification code*: ----

Tensión nominal / *Rated voltage* \* : 12 / 24 V

\* Táchese lo que no proceda / *Strike out what does not apply***MOTIVOS DE LA EXTENSIÓN / REASONS OF EXTENSION**Añadir nuevas variantes / *Add new variants*: SM7303-B-1Lugar / *place*: L'Albornar, Santa Oliva (Tarragona)  
Fecha / *date*: 26/04/2019  
Joan Fonts Sala  
INGENIERO DE ENSAYOS  
TEST ENGINEER\* LOS RESULTADOS PRESENTADOS SE REFIEREN ÚNICAMENTE A LA MUESTRA ENSAYADA.  
*THE PRESENTED RESULTS REFER ONLY TO THE TESTED SAMPLE*\* QUEDA TERMINANTEMENTE PROHIBIDA LA REPRODUCCIÓN PARCIAL DE ESTE INFORME SIN PERMISO EXPRESO DE IDIADA.  
*THE PARTIAL REPRODUCTION OF THIS REPORT WITHOUT THE PERMISSION OF IDIADA IS COMPLETELY FORBIDDEN*

DOCUMENTACIÓN TÉCNICA /  
*TECHNICAL DOCUMENTATION*

# INFORMATION FOLDER

## 1. Specification data

FIRST APPLICATION DATE:		2018-11-07
First extension data		2019-04-22
Reason of extension		<b>Add new variants: SM7303-B-1</b>
Type		SM7302-B
Trade name or mark		 (Sanmak)
Variants		SM7302-B-3 SM7302-B-4 SM7302-B-5 <b><u>SM7303-B-1</u></b>
Function		Special warning lamp
Applicable Regulation		ECE R 65.00 Category TB1
Flash Patterns		One pulse in one flash
Color		Blue
Number and category of Light sources		SM7302-B-3: LED*104 SM7302-B-4: LED*128 SM7302-B-5: LED*152 SM7303-B-1: LED*152
Rated	Voltage	12/24V
	Wattage	SM7302-B-3: 52W SM7302-B-4: 64W SM7302-B-5: 76W SM7303-B-1: 76W
Location of marking	Trade mark	Marked on top cap
	Approval mark	Marked on top cap
Number of separate units (if applicable)		--

## 2. Construction and material

Construction	Material	Remarks
Top cap	ABS	Black
Housing	PC	Clear
Electrical wiring	Cable	

## 3. Name and address of manufacturer

Sanmak Lighting Co., Ltd.  
Block 3, Chuangfu Industry Zone, Lihe Rd., Nanhai District, Foshan, China

**NOTE:** APPROVAL MARKINGS ARE SHOWN IN THE ATTACHED DRAWINGS.  
THIS INFORMATION FOLDER CONSISTS OF 6 PAGES

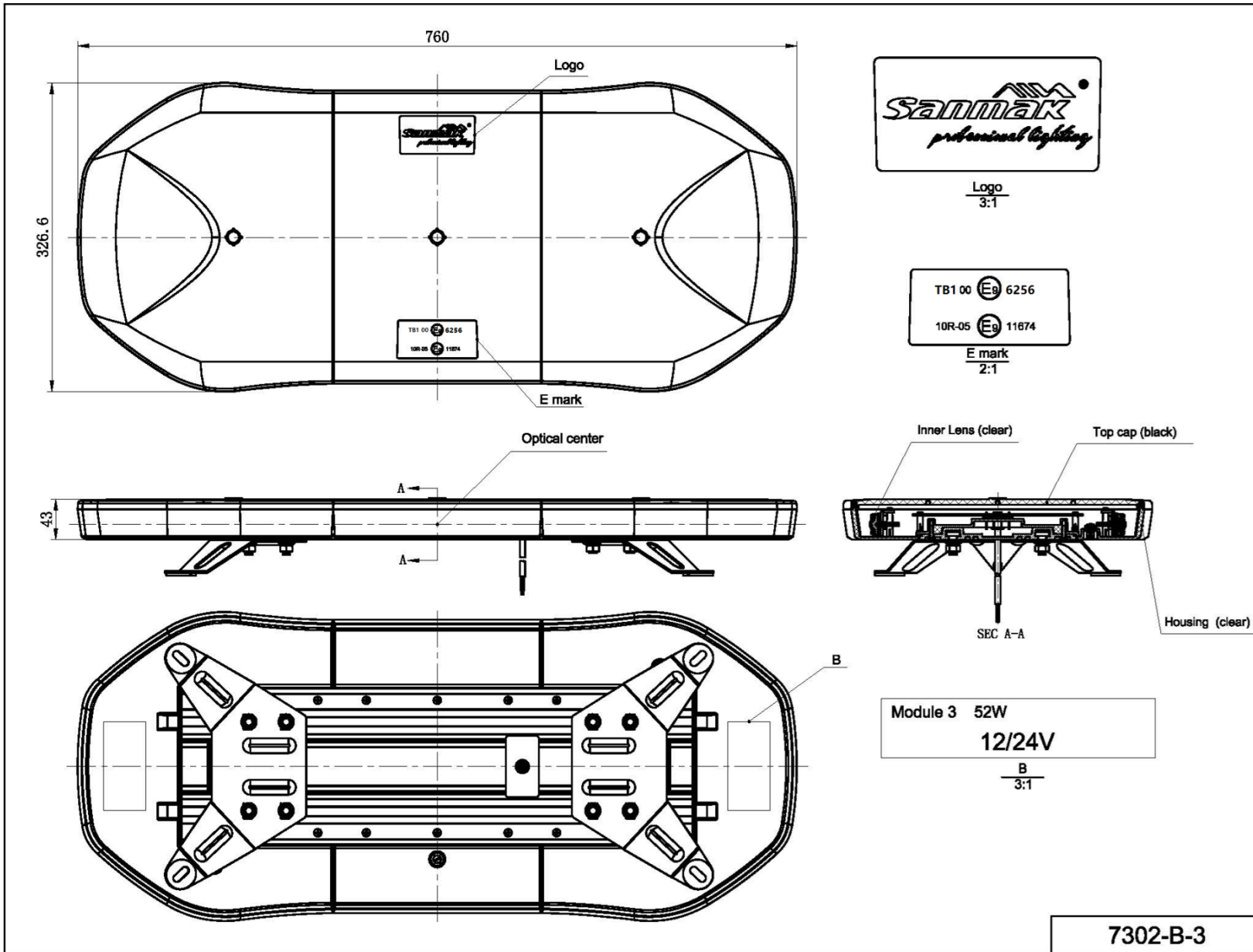

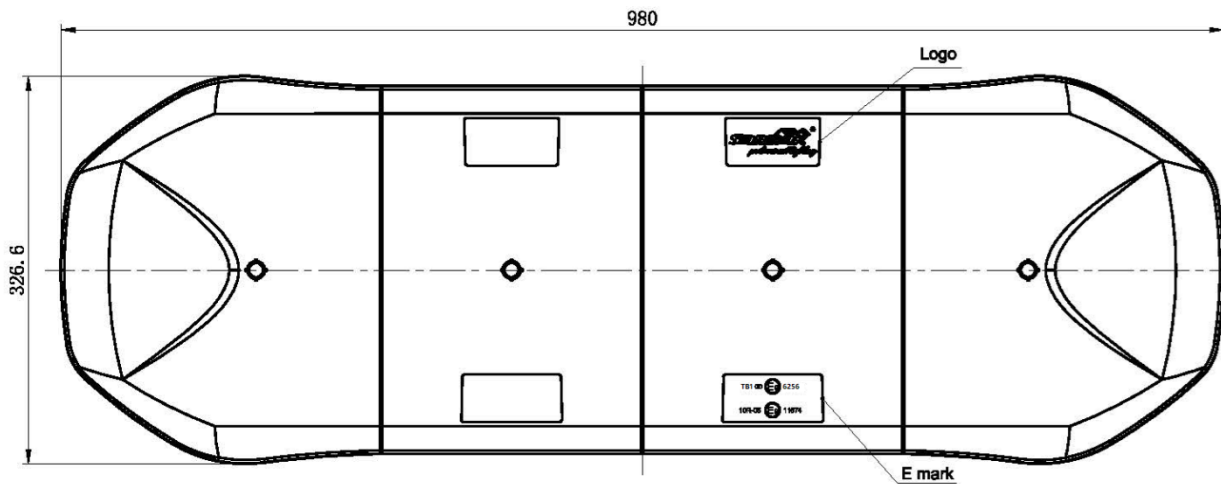

Logo  
3:1

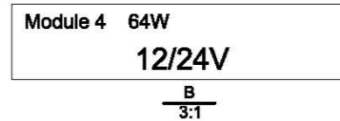
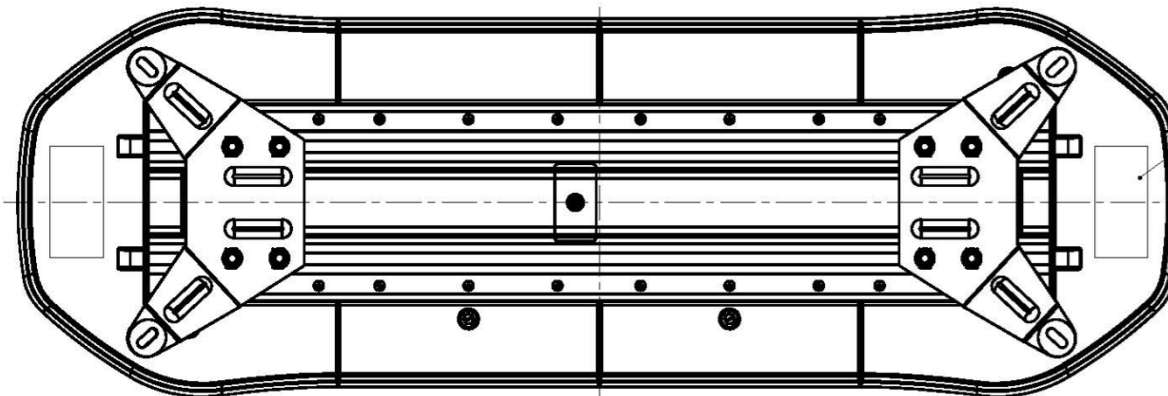
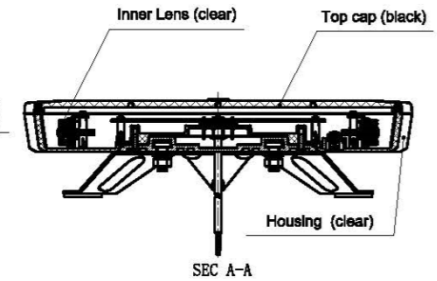
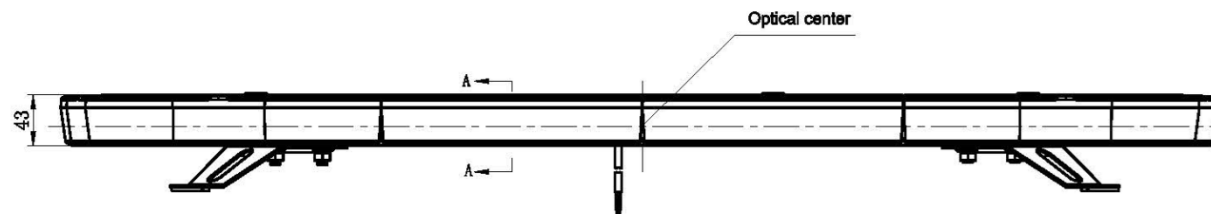
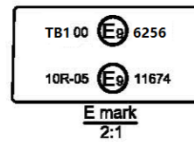

7302-B-4



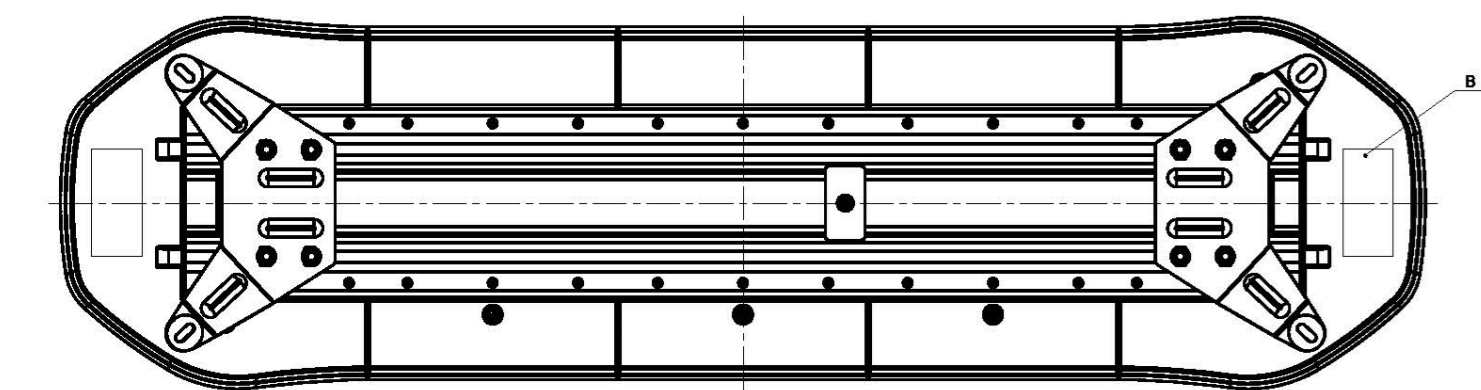
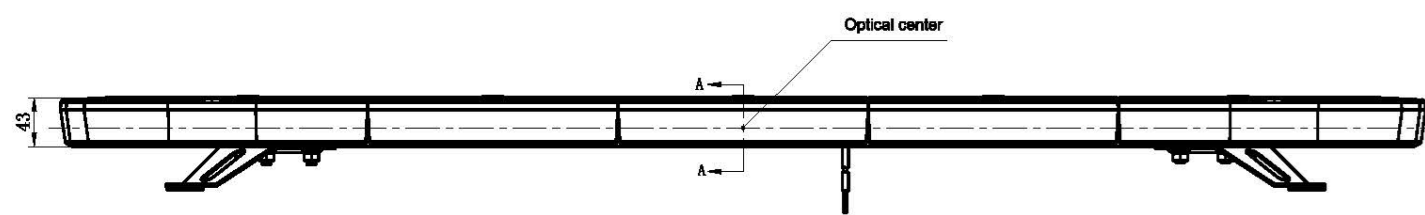
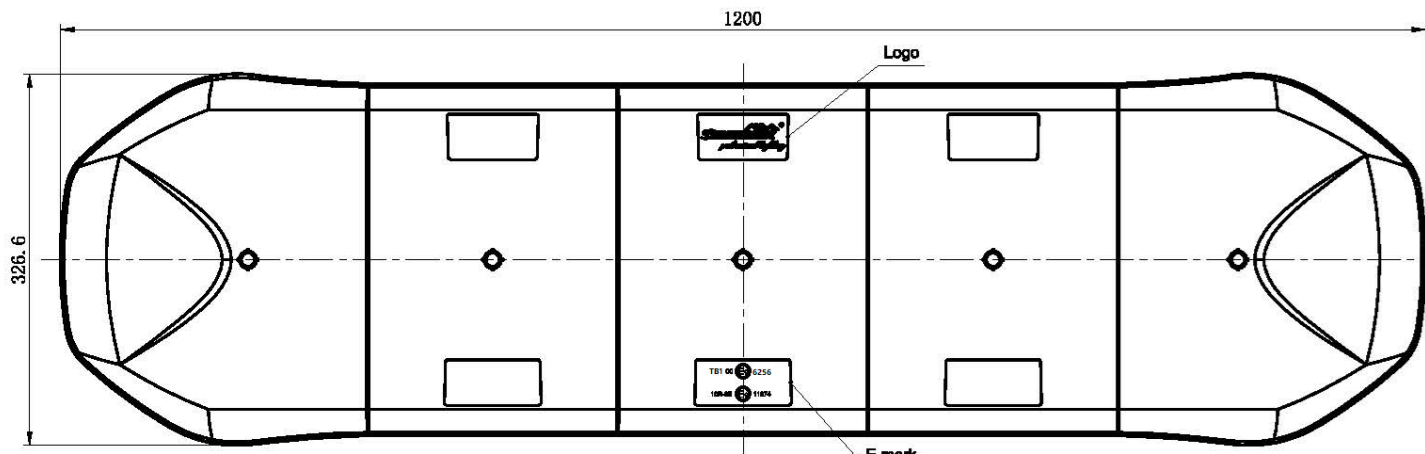

Logo  
3:1

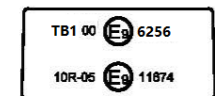

E mark  
2:1

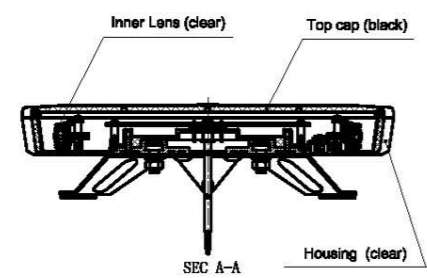

Module 5 76W  
12/24V

B  
3:1

7302-B-5

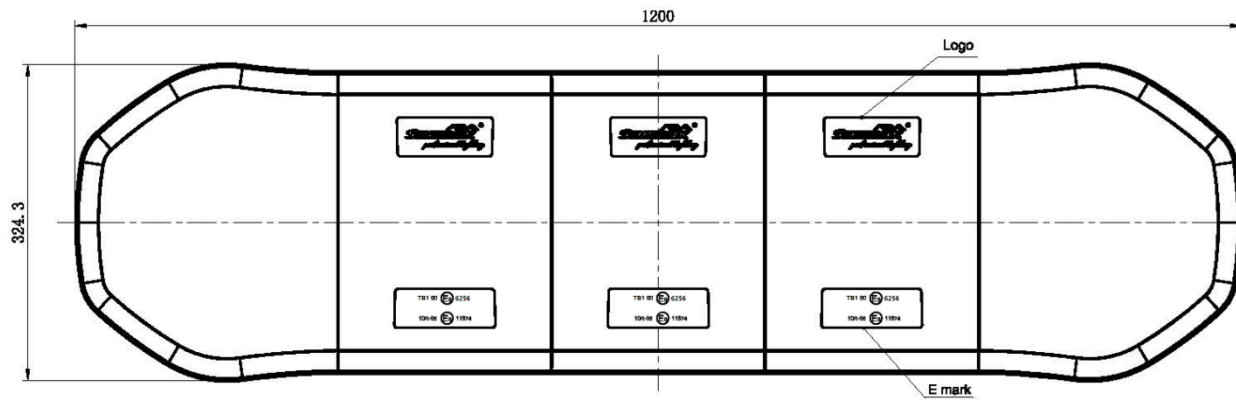

Logo  
3:1

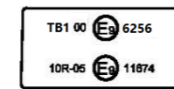

E mark  
2:1

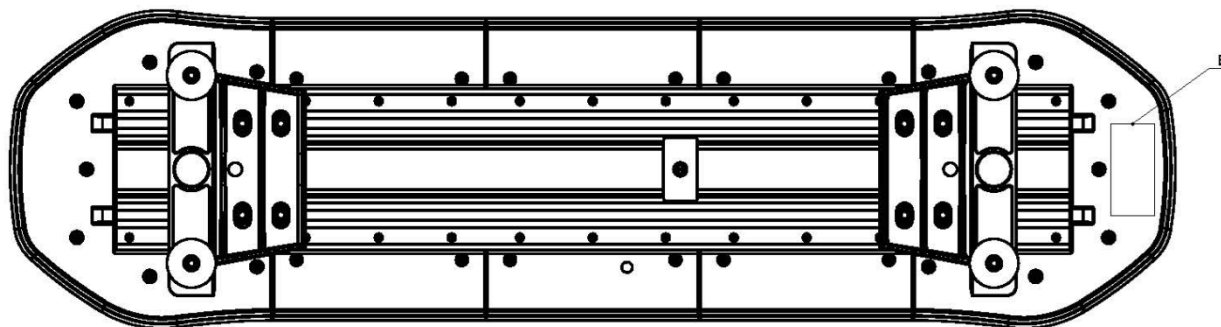
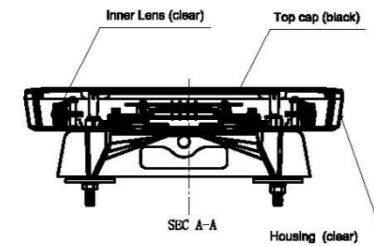
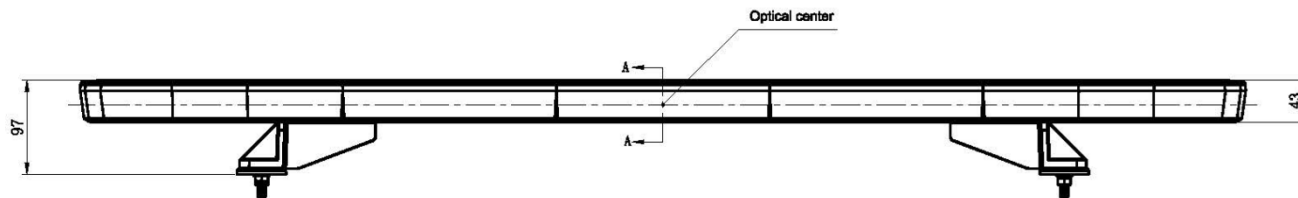

Module 5 76W  
12/24V

B  
3:1

SM7303-B-1

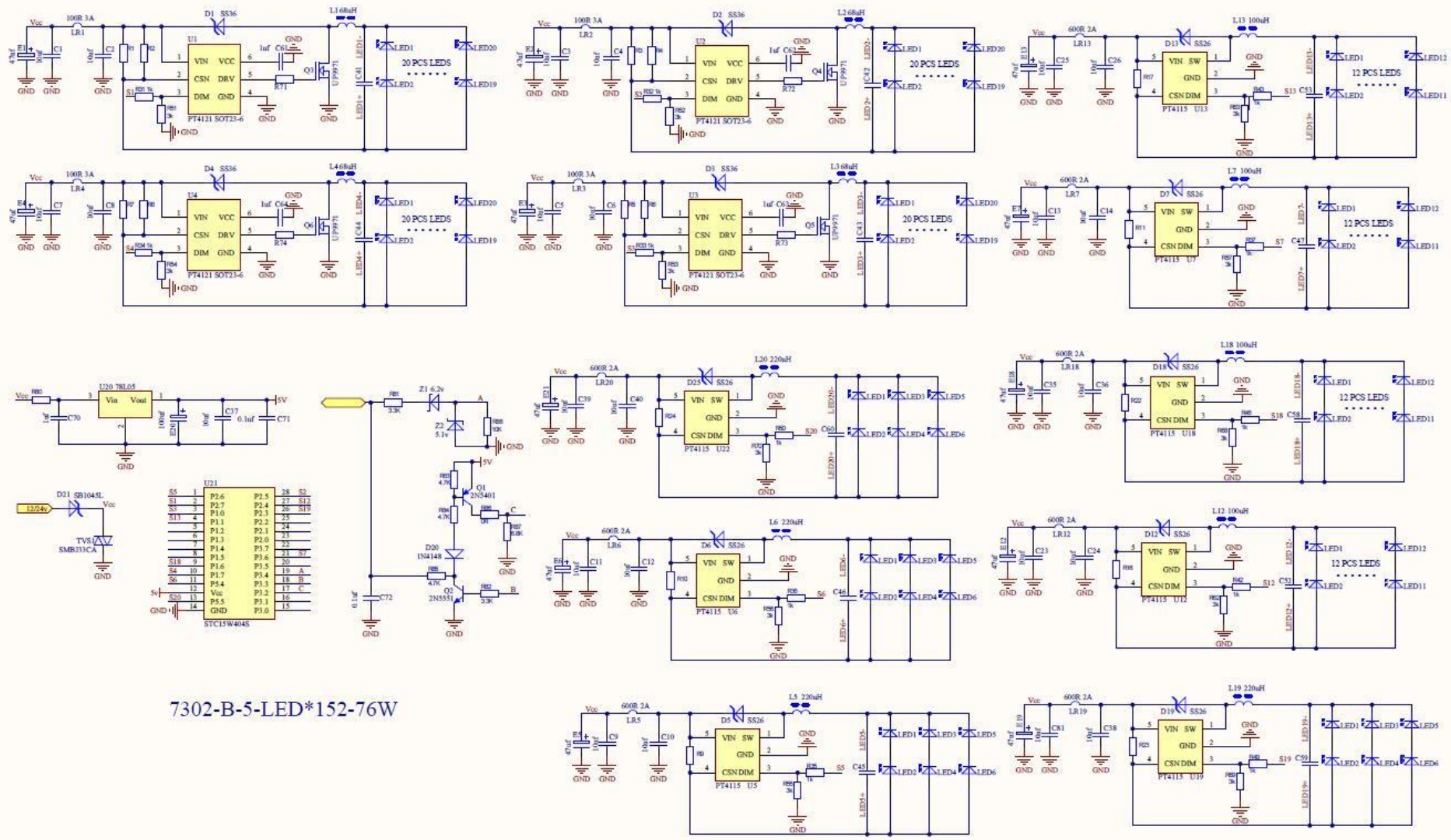

7302-B-5-LED\*152-76W