

Automotive products

RADOX® cables and system solutions

Edition 2020/09



One source from start to finish

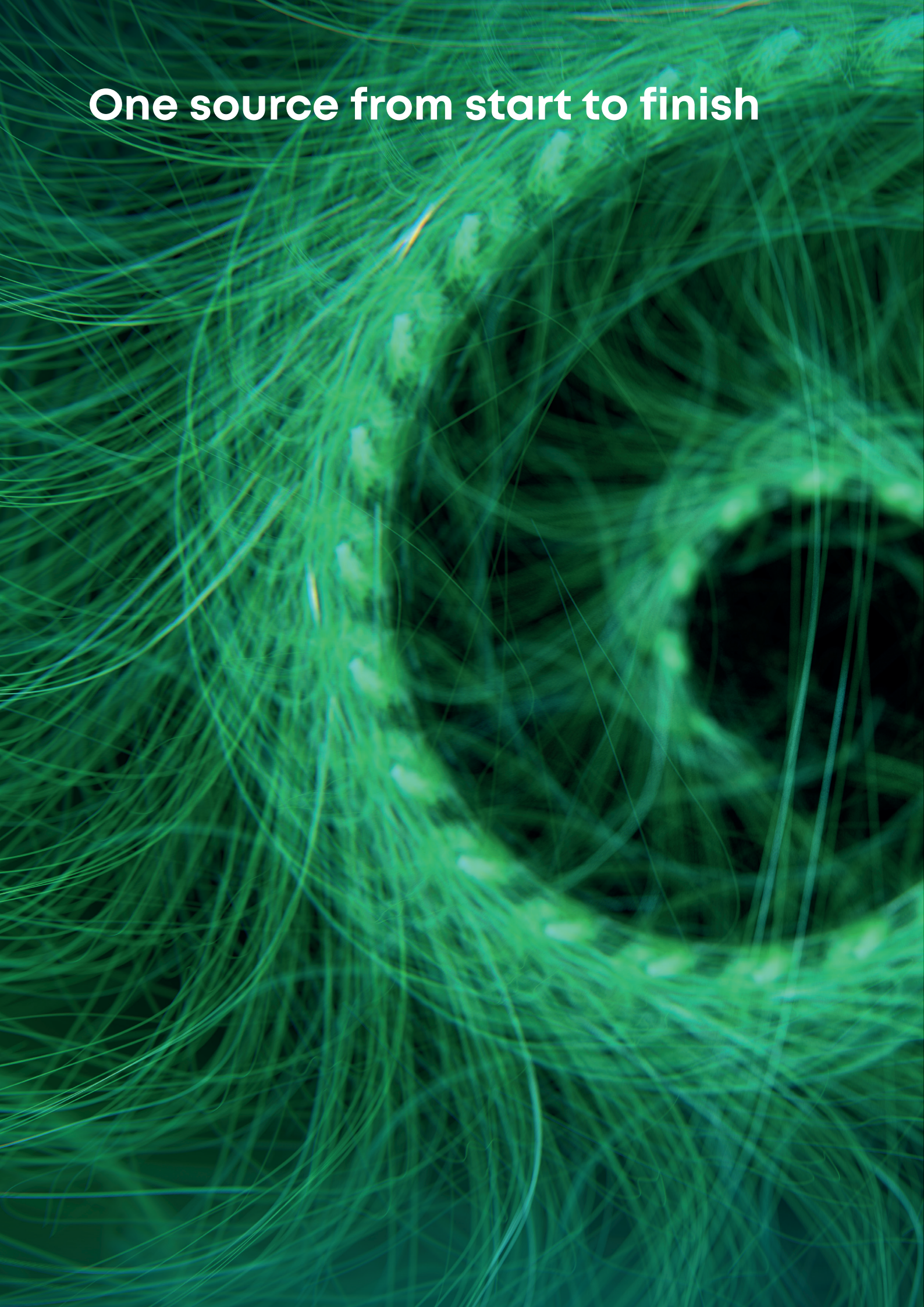

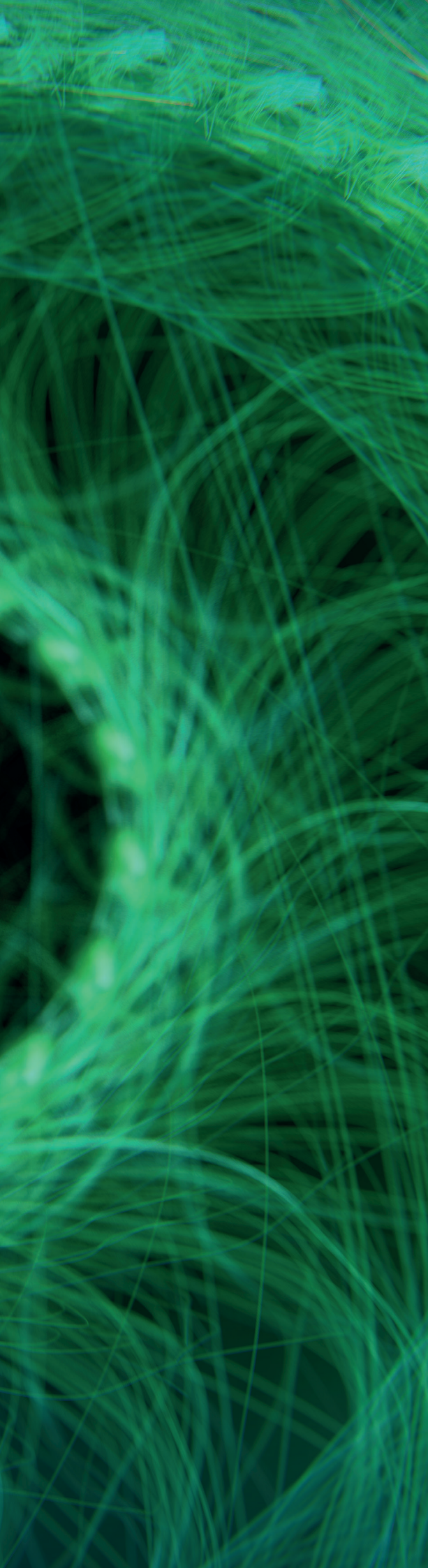

Innovation to achieve the goal

HUBER+SUHNER is a global company with headquarters in Switzerland which develops and manufactures components and system solutions for electrical and optical connectivity. With cables, connectors and systems – developed from the three core technologies of radio frequency, fiber optics and low frequency – the company serves customers in the communication, transportation and industrial sectors.

Increasing engine efficiency, lower power consumption and smaller space restrictions gave rise to higher temperature in the engine compartment. Temperatures of -70 to $+200$ °C (3000 h) are commonplace. The wiring is exposed to various fluids, such as diesel, oils, battery acids, salt water, cleaning agents and humidity in everyday service. HUBER+SUHNER offers the innovative solution for these special requirements: With the well-known RADOX® cables such as single core cables, battery cables and databus cables.

All our products fully comply with the European Directive 2002/95/EC (RoHS).

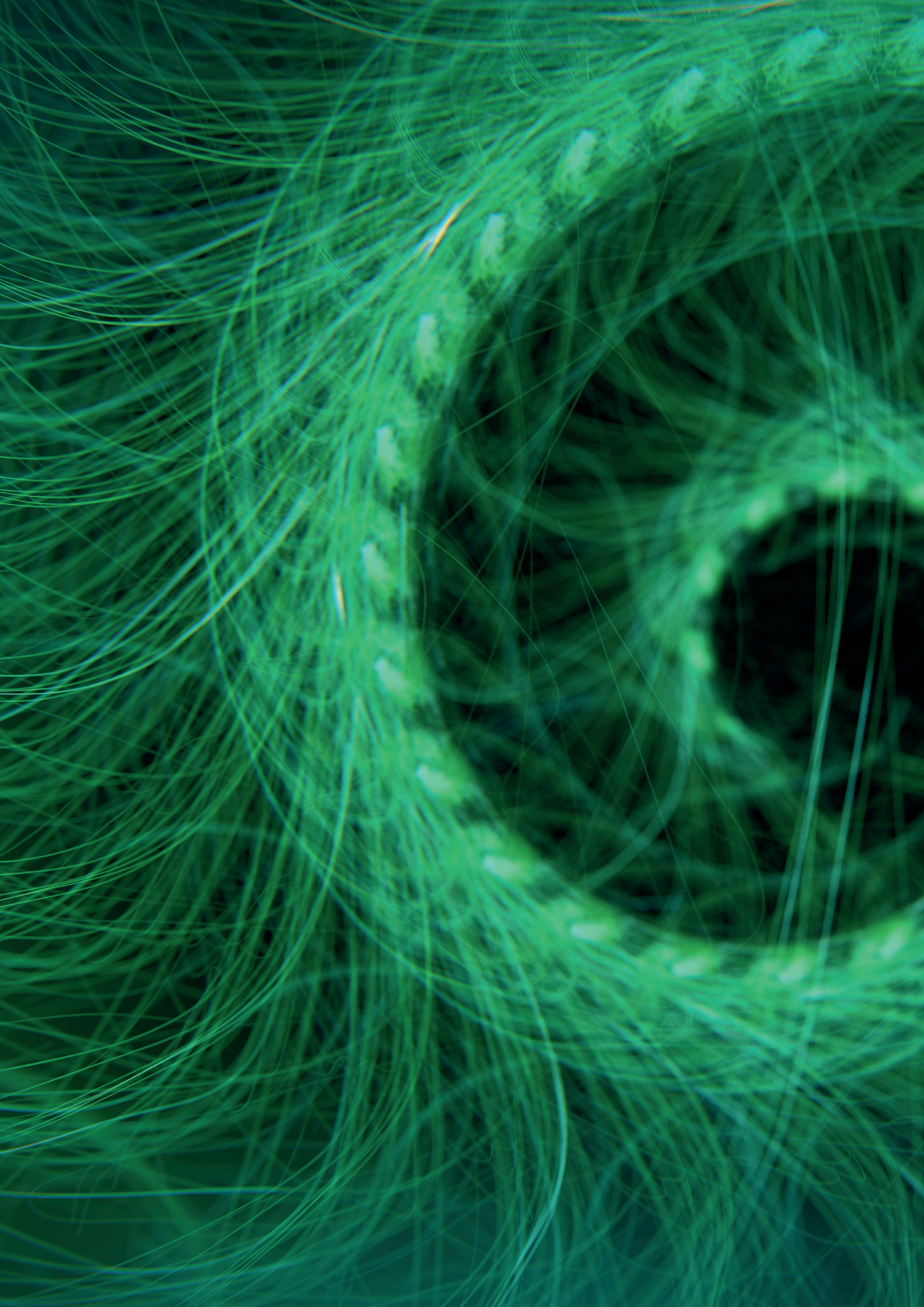



Contents

Automotive wires and cables	6
Automotive cable systems	44
Technical and delivery information	55

RADOX® automotive single core cables



Low voltage cable for road vehicles, class D and F according to ISO 6722 and ISO 19642, temperature rating -40 to +150 °C/200 °C

A growing demand of sensors, higher operating temperatures and restricted space are typical in today's motor compartments. These cables have been developed with these specific requirements in mind.

These cables are class D temperature range cables with reduced outer diameter. They have superb resistance to motor oils, fluids and hydrolysis. Thanks to their electron beam cross-linked RADOX insulation, these cables have excellent resistance to extremes of temperature and abrasion even with reduced outer diameter. Furthermore these RADOX cables have outstanding electrical characteristics.

The characteristics of these RADOX cables make them ideal for use in a wide range of applications, where space is at a premium and where cables are subjected to high temperatures. Even high humidity levels and motor vehicle fluids do not negatively affect the lifetime of the cables.

General features

- Operating temperature range -55 to +200 °C
- Reduced outer diameter
- Resistant to motor fluids, fuels
- Hydrolysis resistant
- Resistant to pressure at high temperatures
- High abrasion resistance
- Excellent electrical characteristics

RADOX 155S FLR	8
RADOX 155S RW	10
ETFE	12
RADOX anticapillary	14

RADOX® 155S FLR (FLR91X and FHLR91X)

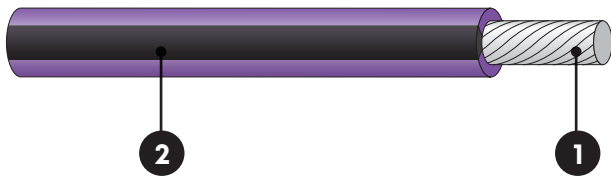

Number of conductors	1
Cross section	0.35 to 6 mm ²
Voltage rating	60/1500 V DC
Temperature range	-55 to +150 °C (3000 h)
Min. bending radius	3 × cable dia.

Composition of cable

1. Conductor stranded tinned or bare copper
2. Insulation RADOX 155S, extruded irradiation cross-linked polyolefin, various colours

Characteristics and specialities

- High and low temperature resistance
- Ozone and weathering resistance
- Resistant to pressure at high temperature
- Resistant to motor oils, fuels and hydrolysis
- Flame retardant
- High abrasion resistance
- Easy to strip and process

Application

Low voltage cable for use in road vehicle applications, such as motor wiring, fan motor or sensor applications.

Standards

Conductor	General
ISO 6722, ISO 19642-3 and -5	ISO 6722, ISO 19642-3 and -5, class D, thin-wall
DIN EN 13602, Cu-ETPI-A (CW003A)	

Customer approvals

- GMW 15626
- VW 60306-1
- Ford ES-AU5T-1A348-AA
- BMW GS 95007
- FCA MS.90034
- JLR TPJLR.18.007
- Scania TB1914
- Volvo STD 525-001
- Bosch N34A AE011D S007

For further technical details please refer to our data sheet STD 548776.

RADOX® 155S FLR (FLR91X and FHLR91X)

Extract from our delivery programme

Dimensions according to ISO 6722-1/ISO 19642, structure A

Cross section	Conductor					Core	
	Nominal mm ²	Number of individual wires	Diameter of individual wires max. mm	Diameter max. mm	Resistance at 20 °C max. Ω/km		Wall thickness min. mm
tinned					bare		
0.35	7	0.26	0.8	55.5	54.4	0.20	1.25 ± 0.05
0.5	19	0.19	1.0	38.2	37.1	0.22	1.5 ± 0.1
0.75	19	0.23	1.2	25.4	24.7	0.24	1.8 ± 0.1
1	19	0.26	1.3	19.1	18.5	0.24	2.0 ± 0.1
1.5	19	0.32	1.7	13.0	12.7	0.24	2.3 ± 0.1
2.5	19	0.41	2.2	7.82	7.60	0.28	2.85 ± 0.15
2.5	37	0.29	2.2	7.82	7.60	0.28	2.85 ± 0.15
4	37	0.38	2.6	4.85	4.71	0.32	3.55 ± 0.15
6	37	0.45	3.1	3.23	3.14	0.32	4.15 ± 0.15

Datasheet STD 548776

Dimensions according to ISO 6722-1/ISO 19642, structure B

Cross section	Conductor					Core	
	Nominal mm ²	Number of individual wires	Diameter of individual wires max. mm	Diameter max. mm	Resistance at 20 °C max. Ω/km		Wall thickness min. mm
tinned					bare		
0.75	24	0.21	1.2	25.4	24.7	0.24	1.8 ± 0.1
1	32	0.21	1.3	19.1	18.5	0.24	2.0 ± 0.1
1.5	30	0.26	1.7	13.0	12.7	0.24	2.3 ± 0.1
2.5	50	0.26	2.2	7.82	7.60	0.28	2.85 ± 0.15
4	56	0.31	2.6	4.85	4.71	0.32	3.55 ± 0.15
6	84	0.31	3.1	3.23	3.14	0.32	4.15 ± 0.15

Datasheet STD 548776

RADOX[®] 155S RW (FLU91X)



Number of conductors	1
Cross section	0.14 to 1 mm ²
Voltage rating	60 V DC
Temperature range	-55 to +150 °C (3000 h)
Min. bending radius	3 × cable dia.

Composition of cable

1. Conductor stranded, tin plated
2. Insulation RADOX 155S, extruded irradiation cross-linked polyolefin, various colours

Characteristics and specialities

- High and low temperature resistance
- Ozone and weathering resistance
- Resistant to pressure at high temperature
- Resistant to motor oils, fuels and hydrolysis
- Flame retardant
- High abrasion resistance
- Easy to strip and process

Application

Low voltage cable for use in road vehicle applications, such as motor wiring, fan motor or sensor applications.

Standards

Conductor	General
ISO 6722, ISO 19642-3 and -5	ISO 6722, ISO 19642-3 and -5, class D, ultra thin-wall
DIN EN 13602, Cu-ETPI-A (CW003A)	

For further technical details please refer to our data sheets STD 548401 and STD 583960.

RADOX® 155S RW (FLU91X)

Extract from our delivery programme

Cross section	Conductor				Core		
	Nominal mm ²	Number of individual wires	Diameter of individual wires max. mm	Diameter max. mm	Resistance at 20 °C max. Ω/km, bare	Wall thickness min. mm	Diameter mm
0.35	7	0.26	0.80	52.0	0.20	1.25 ± 0.05	0.4
0.5	19	0.19	1.00	37.1	0.20	1.40 ± 0.05	0.6
0.75	19	0.23	1.20	24.7	0.21	1.65 ± 0.05	0.8
1.0	19	0.26	1.35	18.5	0.22	1.80 ± 0.05	1.0
1.25	19	0.29	1.40	15.5	0.23	2.00 ± 0.05	1.3
1.5	19	0.32	1.70	12.7	0.23	2.10 ± 0.05	1.5

Datasheet STD 583960

ETFE (FLR7Y and FLU7Y)

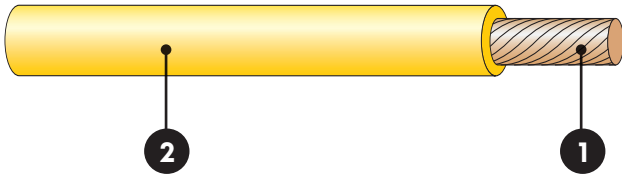

Number of conductors	1
Cross section	0.14 to 6 mm ²
Voltage rating	60/600 V DC
Temperature range	-55 to +200 °C (3000 h)
Min. bending radius	3 × cable dia.

Composition of cable

1. Conductor stranded bare copper
2. Insulation ETFE, extruded fluoropolymer, various colours

Characteristics and specialities

- High and low temperature resistance
- Ozone and weathering resistance
- Resistant to pressure at high temperature
- Resistant to hot motor oils, fuels and hydrolysis
- Flame retardant
- High abrasion resistance
- Easy to strip and process

Application

Low voltage cable for use in road vehicle applications, where constant hot oil immersion is required.

Standards

Conductor	General
ISO 6722, ISO 19642-3 and -5	ISO 6722, ISO 19642-3 and -5, class D, thin-wall and ultra thin-wall
DIN EN 13602, Cu-ETPI-A (CW003A)	

For further technical details please refer to our data sheets STD 378562 (FLR7Y) and STD 585353 (FLU7Y).

ETFE (FLR7Y and FLU7Y)

Extract from our delivery programme

Dimensions according to ISO 6722-1/ISO 19642

Cross section	Conductor					Core		
	Nominal mm ²	Number of individual wires guide value	Diameter of individual wires max. mm	Diameter max. mm	Resistance at 20 °C max. Ω/km		Wall thickness min. mm	Weight nom. kg/100 m
tinned					bare			
0.35	7	0.26	0.8	–	52.0	0.20	0.4	1.25 ± 0.05
1.00	19	0.26	1.35	–	18.5	0.24	1.2	2.00 ± 0.10

Datasheet STD 378562 (FLR7Y)

Dimensions according to ISO 6722-1/ISO 19642

Cross section	Conductor					Core		
	Nominal mm ²	Number of individual wires guide value	Diameter of individual wires max. mm	Diameter max. mm	Resistance at 20 °C max. Ω/km		Wall thickness min. mm	Weight nom. kg/100 m
tinned					bare			
0.25	19	0.13	0.61	86.0	–	0.19	0.33	1.10 ± 0.05
0.35	7	0.26	0.79	–	50.2	0.16	0.45	1.20 ± 0.05
0.50	19	0.19	0.90	–	36.4	0.16	0.58	1.30 ± 0.05
0.75	19	0.23	1.12	–	24.5	0.16	0.84	1.50 ± 0.05
1.0	19	0.26	1.26	–	18.3	0.16	1.06	1.65 ± 0.07
1.5	19	0.32	1.52	–	12.6	0.16	1.55	2.00 ± 0.10
2.5	50	0.26	2.00	–	7.52	0.20	2.59	2.55 ± 0.10
4	56	0.31	2.50	–	4.66	0.24	3.98	3.15 ± 0.10
6	84	0.31	2.98	–	3.11	0.24	5.92	3.65 ± 0.10
10	78	0.41	4.30	–	1.82	0.24	9.89	5.00 ± 0.15

Datasheet STD 585353 (FLU7Y)

RADOX® anticapillary (single insulation)



Number of conductors	1
Cross section	0.35 10 mm ²
Voltage rating	60/1500 V DC
Temperature range	-55 to +150 °C (3000 h)
Min. bending radius	3 × cable dia.

Composition of cable

1. Conductor stranded tinned or bare copper, special coating
2. Insulation RADOX 155S, extruded irradiation cross-linked polyolefin (FLR91X), various colours

Characteristics and specialities

- Barrier sealed, avoids penetration of fluids along conductor (fluids such as water and AdBlue)
- High and low temperature resistance
- Ozone and weathering resistance
- Resistant to pressure at high temperature
- Resistant to motor oils, fuels, hydrolysis and AdBlue
- Flame retardant
- High abrasion resistance
- Easy to strip and process

Application

Low voltage cable with anticapillary properties for use in road vehicle applications.

Standards

Conductor	General
ISO 6722, ISO 19642-3 and -5	ISO 6722, ISO 19642-3 and -5, class D, thin-wall
DIN EN 13602, Cu-ETPI-A (CW003A)	

Customer approvals

- Daimler DR 15863
- BMW 9 338 777.9 – 796.9
- JLR
- Bosch N34_AE011D_S014
- Ford ES-AU5T-1A348-AA

For further technical details please refer to our data sheets STD 582554D, STD 412701 (filled with fluorinated grease), STD 582272 (filled with silicon grease).

RADOX[®] anticapillary (single insulation)

Extract from our delivery programme

Dimensions according to ISO 6722-1/ISO 19642 structure A

Cross section	Conductor					Core	
	Nominal mm ²	Number of individual wires	Diameter of individual wires max. mm	Diameter max. mm	Resistance at 20 °C max. Ω/km		Wall thickness min. mm
tinned					bare		
0.35	7	0.26	0.8	54.5	52.0	0.20	1.25 ± 0.05
0.5	19	0.19	1.0	38.2	37.1	0.22	1.5 ± 0.1
0.75	19	0.23	1.2	25.4	24.7	0.24	1.8 ± 0.1
1.0	19	0.26	1.35	19.1	18.5	0.24	2.0 ± 0.1
1.5	19	0.32	1.7	13.0	12.7	0.24	2.3 ± 0.1

Datasheet STD 582554

Dimensions according to ISO 6722-1/ISO 19642

Cross section	Conductor					Core	
	Nominal mm ²	Number of individual wires	Diameter of individual wires max. mm	Diameter max. mm	Resistance at 20 °C max. Ω/km		Wall thickness min. mm
tinned					bare		
2	19	0.38	1.86	9.69	9.42	0.28	2.65 ± 0.15
2.5	19	0.42	2.2	7.82	7.60	0.28	2.85 ± 0.15
4	19	0.55	2.75	4.85	4.71	0.32	3.55 ± 0.15
6	19	0.67	3.3	3.23	3.14	0.32	4.15 ± 0.15
10	37	0.61	3.9	1.85	1.82	0.73	5.75 ± 0.20

Datasheet STD 412701

RADOX[®] anticapillary (double insulation)



Number of conductors	1
Cross section	0.35 to 6 mm ²
Voltage rating	60/1500 V DC
Temperature range	-55 to +150 °C (3000 h)
Min. bending radius	3 × cable dia.

Composition of cable

- | | |
|---------------|--|
| 1. Conductor | stranded tinned or bare copper, special coating |
| 2. Insulation | RADOX 155S, extruded irradiation cross-linked polyolefin |
| 3. Insulation | extruded irradiation crosslinked fluoropolymer (PVDF-X) for hot oil applications |

Characteristics and specialities

- Barrier sealed, avoids penetration of fluids along conductor (fluids such as water, AdBlue and hot oils)
- High and low temperature resistance
- Ozone and weathering resistance
- Resistant to pressure at high temperature
- Resistant to motor oils, fuels and hydrolysis
- Flame retardant
- High abrasion resistance
- Easy to strip and process

Application

Low voltage cable with anticapillary properties for use in road vehicle applications.

Standards

Conductor	General
DIN 72551 part 6	ISO 6722 class D, thin-wall
ISO 6722	DIN 72551 part 5 (1993)
DIN EN 13602, Cu-ETPI-A (CW003A)	LV 112

Customer approvals

- Bosch N34A AEO11D_S015

For further technical details please refer to our data sheets STD 470829 (filled with fluorinated grease), STD 759203 (filled with silicon grease).

RADOX[®] anticapillary (double insulation)

Extract from our delivery programme

Dimensions according to ISO 6722/ISO 19642 structure B

Cross section	Conductor					Core	
	Nominal mm ²	Number of individual wires	Diameter of individual wires max. mm	Diameter max. mm	Resistance at 20 °C max. Ω/km		Wall thickness min. mm
tinned					bare		
0.5	19	0.19	1.0	38.2	37.1	0.22	1.5 ± 0.1
0.75	19	0.23	1.2	25.4	24.7	0.24	1.8 ± 0.1
1	19	0.26	1.3	19.1	18.5	0.24	2.0 ± 0.1
1.5	19	0.32	1.7	13.0	12.7	0.24	2.3 ± 0.1
2	19	0.38	1.8	9.69	9.42	0.28	2.65 ± 0.15
4	19	0.55	2.5	4.85	4.71	0.32	3.55 ± 0.15

Datasheet STD 470829

Dimensions according to ISO 6722/ISO 19642

Cross section	Conductor					Core	
	Nominal mm ²	Number of individual wires	Diameter of individual wires max. mm	Diameter max. mm	Resistance at 20 °C max. Ω/km		Wall thickness min. mm
tinned					bare		
0.5	19	0.19	1.0	38.2	37.1	0.22	1.5 ± 0.1
0.75	19	0.23	1.2	25.4	24.7	0.24	1.8 ± 0.1
1	19	0.26	1.35	19.1	18.5	0.24	2.0 ± 0.1
1.5	19	0.32	1.7	13.0	12.7	0.24	2.3 ± 0.1
2.5	19	0.42	2.2	7.82	7.60	0.28	2.85 ± 0.15

Datasheet STD 759203

RADOX® battery cables – thin-wall, flexible



Power cables for road vehicles, class D according to ISO 6722, operating temperature –40 to +150 °C

RADOX battery cables are high temperature resistant products with a reduced outer diameter. The cable is highly resistant to temperature, ozone, weathering, hydrolysis and has excellent resistance to battery acid and cooling agents. It is also resistant against oils, fuels and other fluids used inside and outside of the motor compartment.

Thanks to its electron beam cross-linked RADOX insulation, the cable has, despite the reduced outer diameter, excellent resistance to heat pressure and abrasion. In addition, the RADOX battery cable has outstanding dielectric properties. The flame retardant insulation does not melt or flow at high temperatures and is easy to strip.

General features

- Operating temperature –70 to +150 °C
- Outstanding flexibility
- Reduced outer diameter
- Resistant to motor oils, battery acid and fuels
- High resistance to heat pressure
- Excellent abrasion resistance

RADOX 155 battery cable	20
RADOX Elastomer S (REMS) battery cable	24
RADOX screened battery cable	30
RADOX screened multi core cable	32

RADOX® 155 battery cable, flexible (FLR4G and FHLR4G)

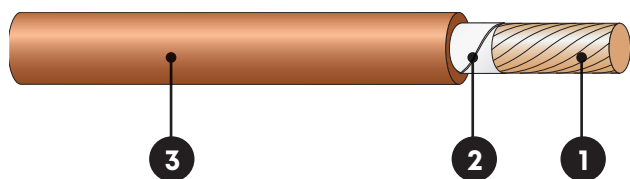

Number of conductors	1
Cross section	10 to 150 mm ²
Voltage rating	1000 V AC/1500 V DC
Temperature range	-55 to +150 °C (3000 h)
Min. bending radius	3 × cable dia.

Composition of cable

- | | |
|-----------------|--|
| 1. Conductor | stranded bare copper |
| 2. Plastic tape | optional |
| 3. Insulation | RADOX 155, extruded irradiation cross-linked polyolefin, various colours |

Characteristics and specialities

- Excellent high and low temperature resistance
- Ozone, weathering and hydrolysis resistance
- Outstanding resistance against battery acids, humidity, petrol, brake fluids, engine coolant, window washer, fluids, diesel and various oils
- Flame retardant
- Easy to strip and process

Application

ADR approved battery or power cable for use in road vehicle applications.

Standards

Conductor	General
ISO 6722-1	ISO 6722, ISO 19642-5, class D, thin-wall
DIN EN 13602, Cu-ETPI-A (CW003A)	ADR approved

Customer approvals

- GMW 15626
- VW 60306-1
- Ford ES-AU5T-1A348-AA
- BMW GS 95007
- FCA MS.90034
- JLR TPJLR.18.007
- Scania TB1914
- Volvo STD 525-001
- Bosch N34A AE011D S007
- VW 75210-1

For further technical details please refer to our data sheet STD 718404.

RADOX® 155 battery cable, flexible (FLR4G and FHLR4G)

Extract from our delivery programme

Cross section	Conductor				Core		
	Nominal mm ²	Number of individual wires guide value	Diameter of individual wires max. mm	Diameter max. mm	Resistance at 20 °C max. Ω/km	Wall thickness min. mm	Weight nom. kg/100 m
8	60	0.41	3.8	2.38	0.40	8.0	5.05 ± 0.15
10	78	0.41	4.3	1.82	0.50	10.5	5.75 ± 0.20
12	92	0.41	4.7	1.52	0.50	12.0	6.10 ± 0.20
16	126	0.41	5.4	1.16	0.52	16.5	6.90 ± 0.20
20	154	0.41	6.2	0.955	0.52	20.0	7.60 ± 0.20
25	189	0.41	6.7	0.743	0.55	24.2	8.20 ± 0.20
30	224	0.41	7.4	0.647	0.64	29.0	9.10 ± 0.25
35	273	0.41	7.9	0.527	0.65	35.0	9.70 ± 0.25
40	301	0.41	8.5	0.473	0.73	38.7	10.40 ± 0.25
50	385	0.41	9.4	0.368	0.80	49.2	11.50 ± 0.25
60	294	0.51	10.6	0.315	0.80	57.8	12.60 ± 0.25
70	360	0.51	11.6	0.259	0.80	69.7	13.70 ± 0.25
95	480	0.51	13.5	0.196	0.90	93.8	16.20 ± 0.30
120	589	0.51	15.1	0.153	0.90	114.7	18.00 ± 0.30
150	741	0.51	17.0	0.122	1.00	143.4	20.00 ± 0.30

Datasheet STD 718404

RADOX® 155 battery cable, aluminium (FLR4G or FHLR4G)

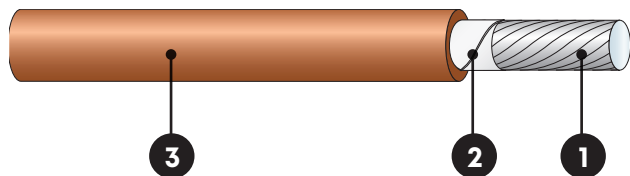

Number of conductors	1
Cross section	10 to 120 mm ²
Voltage rating	1000 V AC/1500 V DC
Temperature range	-55 to +150 °C (3000 h)
Min. bending radius	3 × cable dia.

Composition of cable

- | | |
|-----------------|--|
| 1. Conductor | stranded aluminium |
| 2. Plastic tape | optional |
| 3. Insulation | RADOX 155, extruded irradiation cross-linked polyolefin, various colours |

Characteristics and specialities

- Excellent high and low temperature resistance
- Ozone, weathering and hydrolysis resistance
- Outstanding resistance against battery acids, humidity, petrol, brake fluids, engine coolant, window washer, fluids, diesel and various oils
- Flame retardant
- Easy to strip and process

Application

ADR approved battery or power cable for use in road vehicle applications.

Standards

Conductor	General
ISO 6722-2	ISO 6722-2, ISO 19642-6, class D, thin-wall
ISO 6892-1	
ASTM B231	
EN 573-1	

For further technical details please refer to our data sheet STD 776028.

RADOX[®] 155 battery cable, aluminium (FLR4G or FHLR4G)

Extract from our delivery programme

Cross section	Conductor				Core		
	Nominal mm ²	Number of individual wires guide value	Diameter of individual wires max. mm	Diameter max. mm	Resistance at 20 °C max. Ω/km	Wall thickness min. mm	Weight nom. kg/100 m
16	80	0.52	5.40	1.93	0.52	8.7	6.75 ± 0.20
25	122	0.52	6.70	1.24	0.52	12.8	8.40 ± 0.20
35	172	0.52	7.90	0.878	0.64	18.3	10.05 ± 0.25
50	247	0.52	9.40	0.368	0.72	21.3	11.50 ± 0.25
60	289	0.52	10.50	0.613	0.80	28.1	12.85 ± 0.25
70	351	0.52	10.60	0.432	0.80	34.1	13.85 ± 0.25
95	472	0.52	13.50	0.327	1.09	49.2	16.20 ± 0.30
120	305	0.72	15.10	0.255	1.28	68.0	18.00 ± 0.30

Datasheet STD 776028

RADOX® Elastomer S (REMS) battery cable, flexible (FLR13X)



Number of conductors	1
Cross section	10 to 150 mm ²
Voltage rating	600 V AC/900 V DC
Temperature range	-70 to +150 °C (3000 h)
Min. bending radius	3 × cable dia.

Composition of cable

- | | |
|-----------------|--|
| 1. Conductor | stranded bare copper |
| 2. Plastic tape | optional |
| 3. Insulation | RADOX Elastomer S (REMS), extruded irradiation cross-linked copolymer, various colours |

Characteristics and specialities

- Excellent high and low temperature resistance
- Very flexible
- Ozone and weathering resistance
- Outstanding resistance against battery acids, diesel, various oils, engine coolant and window washer fluids
- Resistance against humidity, petrol and brake fluids
- Flame retardant
- Easy to strip and process

Application

Flexible battery or power cable for use in road vehicle applications.

Standards

Conductor	General
ISO 6722 -1, ISO 19642-5	ISO 6722, ISO 19642-5 class D, thin-wall
DIN EN 13602, Cu-ETPI-A (CW003A)	

For further technical details please refer to our data sheet STD 565167

RADOX[®] Elastomer S (REMS) battery cable, flexible (FLR13X)

Extract from our delivery programme

Cross section	Conductor				Cable		
	Nominal mm ²	Number of individual wires guide value	Diameter of individual wires max. mm	Diameter max. mm	Resistance at 20 °C max. Ω/km	Wall thickness min. mm	Weight nom. kg/100 m
10	78	0.41	4.3	1.82	0.50	10.7	5.75 ± 0.15
12	92	0.41	4.65	1.52	0.50	12.1	6.05 ± 0.15
16	126	0.41	5.4	1.16	0.52	16.7	6.90 ± 0.20
20	154	0.41	6.2	0.955	0.52	20.2	7.60 ± 0.20
25	189	0.41	6.7	0.743	0.55	24.5	8.20 ± 0.20
30	224	0.41	7.4	0.647	0.64	29.9	9.10 ± 0.25
35	273	0.41	7.9	0.527	0.65	35.4	9.70 ± 0.25
50	385	0.41	9.4	0.368	0.80	49.8	11.50 ± 0.25
70	360	0.51	11.6	0.259	0.80	70.4	13.70 ± 0.25
95	480	0.51	13.5	0.196	0.90	95.0	16.25 ± 0.30
120	589	0.51	15.1	0.153	0.90	115.9	18.00 ± 0.30

Datasheet STD 565167

RADOX® Elastomer S (REMS) battery cable, high flexible (FLR13X)



Number of conductors	1
Cross section	10 to 150 mm ²
Voltage rating	600 V AC/900 V DC
Temperature range	-70 to +150 °C (3000 h)
Min. bending radius	3 × cable dia.

Composition of cable

- | | |
|-----------------|--|
| 1. Conductor | stranded bare copper |
| 2. Plastic tape | optional |
| 3. Insulation | RADOX Elastomer S (REMS), extruded irradiation cross-linked copolymer, various colours |

Characteristics and specialities

- Excellent high and low temperature resistance
- Very flexible
- Ozone and weathering resistance
- Outstanding resistance against battery acids, diesel, various oils, engine coolant and window washer fluids
- Resistance against humidity, petrol and brake fluids
- Flame retardant
- Easy to strip and process

Application

High flexible battery or power cable for use in road vehicle applications.

Standards

Conductor	General
ISO 6722 -1, ISO 19142-5	ISO 6722, ISO 19642-5 class D, thin-wall
DIN EN 13602, Cu-ETPI-A (CW003A)	

For further technical details please refer to our data sheet STD 451483.

RADOX[®] Elastomer S (REMS) battery cable, high flexible (FLR13X)

Extract from our delivery programme

Cross section	Conductor				Cable		
	Nominal mm ²	Number of individual wires guide value	Diameter of individual wires max. mm	Diameter max. mm	Resistance at 20 °C max. Ω/km	Wall thickness min. mm	Weight nom. kg/100 m
16	490	0.21	5.4	1.16	0.52	16.7	6.80 ± 0.20
25	760	0.21	7.0	0.743	0.52	25.0	8.45 ± 0.25
35	1'064	0.21	8.3	0.527	0.64	35.5	10.15 ± 0.25
50	1'520	0.21	9.9	0.368	0.71	50.3	11.95 ± 0.25
70	2'146	0.21	11.8	0.259	0.80	69.6	14.10 ± 0.30
95	2'849	0.21	13.3	0.196	0.90	93.5	16.40 ± 0.30
120	3'538	0.21	15.3	0.153	1.28	120.1	19.40 ± 0.30

Datasheet STD 451483

RADOX® Elastomer S (REMS) battery cable, flexible, thick-wall (FL13X)



Number of conductors	1
Cross section	10 to 150 mm ²
Voltage rating	600 V AC/900 V DC
Temperature range	-70 to +150 °C (3000 h)
Min. bending radius	3 × cable dia.

Composition of cable

- | | |
|-----------------|--|
| 1. Conductor | stranded bare copper |
| 2. Plastic tape | optional |
| 3. Insulation | RADOX Elastomer S (REMS), extruded radiation cross-linked copolymer, various colours |

Characteristics and specialities

- Excellent high and low temperature resistance
- Very flexible
- Ozone and weathering resistance
- Outstanding resistance against battery acids, diesel, various oils, engine coolant and window washer fluids
- Resistance against humidity, petrol and brake fluids
- Flame retardant
- Easy to strip and process

Application

ADR approved, thick-wall battery or power cable for use in road vehicle applications.

Standards

Conductor	General
ISO 6722 -1, ISO 19642-5	ISO 6722, ISO 19642-5 class D, thick-wall
DIN EN 13602, Cu-ETPI-A (CW003A)	ADR approved

For further technical details please refer to our data sheets STD 711923 and STD 412055.

RADOX[®] Elastomer S (REMS) battery cable, flexible, thick-wall (FL13X)

Extract from our delivery programme

Cross section	Conductor				Cable		
	Nominal mm ²	Number of individual wires guide value	Diameter of individual wires max. mm	Diameter max. mm	Resistance at 20 °C max. Ω/km	Wall thickness min. mm	Weight nom. kg/100 m
10	78	0.41	4.3	1.82	0.80	11.4	6.30 ± 0.20
16	126	0.41	5.4	1.16	1.10	18.6	8.10 ± 0.20
25	189	0.41	6.7	0.743	1.40	28.3	10.15 ± 0.25
35	273	0.41	7.9	0.527	1.40	39.1	11.35 ± 0.25
50	385	0.41	9.4	0.368	1.60	54.4	13.25 ± 0.25
70	360	0.51	11.6	0.259	1.45	75.0	15.20 ± 0.30
95	480	0.51	13.5	0.196	1.70	100.2	17.70 ± 0.30
120	589	0.51	15.1	0.153	1.35	117.8	18.50 ± 0.30

Datasheet TD 711923

RADOX[®] screened single core cable (FHLR91XC13X and FHLR4GC13X)

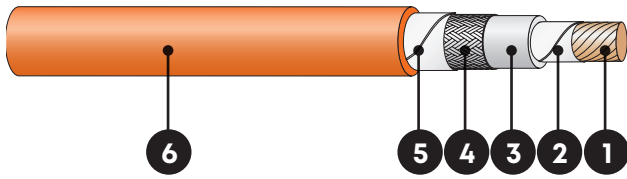

Number of conductors	1
Cross section	1.5 to 150 mm ²
Voltage rating	1000 V AC/1500 V DC
Temperature range	-55 to +150 °C (3000 h)
Min. bending radius	4 × cable dia.

Composition of cable

1. Conductor	stranded bare copper
2. Tape	plastic
3. Insulation	RADOX 155S (91X) for 1.5, 2.5, 4.0, 6.0 mm ² RADOX 155 (4G) for > 6 mm ²
4. EMC screen	tin plated copper braid optimised
5. Tape	plastic (PEC)
6. Sheath	RADOX Elastomer S (13X), colour: orange

Characteristics and specialities

- Excellent high and low temperature resistance
- Ozone and weathering resistance
- Outstanding resistance against battery acid, diesel, various oils, engine coolant and window washer fluids
- Resistance against humidity, petrol and brake fluids
- Flame retardant
- Soldering iron resistant
- Easy to strip and process

Application

Screened power cable for use in hybrid and electrical vehicles.

Standards

Conductor	General
ISO 6722 -1, ISO 19642-9	ISO 6722, ISO 19642-9 class D, thin-wall
DIN EN 13602, Cu-ETPI-A (CW003A)	

For further technical details please refer to our data sheet STD 806104.

RADOX[®] screened single core cable (FHLR91XC13X and FHLR4GC13X)

Extract from our delivery programme

Cross section	Conductor				Cable				
	Nominal mm ²	Number of ind. wires guide value	Dia. of ind. wires max. mm	Diameter max. mm	Resistance at 20 °C max. Ω/km	Diameter of insulation nom. mm	Diameter of screen max. mm	Overall-diameter nom. mm	Z _T at 30 MHz nom. mΩ/m
2.5	50	0.26	2.0	7.60	2.85	3.3	5.0 ± 0.2	100	4.9
4	56	0.31	2.5	4.71	3.55	4.0	5.8 ± 0.2	110	7.0
6	84	0.31	3.0	3.14	4.15	4.7	6.6 ± 0.3	70	9.8
8	60	0.41	3.8	2.38	5.05	5.6	7.6 ± 0.3	40	12.5
10	78	0.41	4.3	1.82	5.75	6.3	8.4 ± 0.3	30	15.8
12	92	0.41	4.7	1.52	6.10	6.7	8.9 ± 0.3	30	17.9
16	126	0.41	5.4	1.16	6.90	7.5	9.7 ± 0.3	40	23.0
20	154	0.41	6.2	0.955	7.60	8.3	10.6 ± 0.3	30	28.2
25	189	0.41	6.7	0.743	8.20	8.9	11.2 ± 0.3	40	32.8
30	224	0.41	7.4	0.647	9.10	9.8	12.1 ± 0.3	30	38.5
35	273	0.41	7.9	0.527	9.70	10.4	12.7 ± 0.3	60	44.7
40	301	0.41	8.5	0.473	10.40	11.3	13.6 ± 0.3	20	51.3
50	385	0.41	9.4	0.368	11.50	12.6	14.9 ± 0.3	30	64.2
60	294	0.51	10.6	0.315	12.60	13.5	15.9 ± 0.3	30	73.1
70	360	0.51	11.6	0.259	13.70	14.6	17.0 ± 0.3	30	85.8
95	480	0.51	13.5	0.196	16.20	17.3	19.9 ± 0.4	20	115.3
120	589	0.51	15.1	0.153	18.00	19.1	22.6 ± 0.4	20	145.5
150	741	0.51	17.0	0.122	20.00	21.3	24.9 ± 0.5	30	177.4

Datasheet TD 806104

RADOX[®] screened FLEX single core cable (FHLR4GC13X)

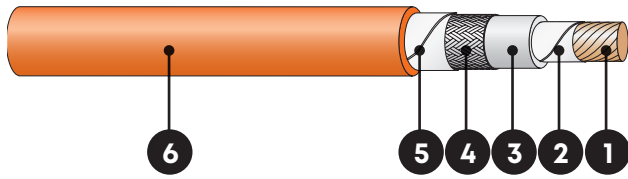

Number of conductors	1
Cross section	16 to 120 mm ²
Voltage rating	1000 V AC/1500 V DC
Temperature range	-55 to +150 °C (3000 h)
Min. bending radius	3 × cable dia.

Composition of cable

1. Conductor	stranded bare copper ISO structure C (flexible)
2. Tape	plastic
3. Insulation	RADOX 155 (4G)
4. EMC screen	tin plated copper braid optimized
5. Tape	plastic (PEC)
6. Sheath	RADOX Elastomer S (13X), colour: orange

Characteristics and specialities

- Excellent high and low temperature resistance
- Enhanced cable flexibility
- Easy and low-effort cable routing
- Ozone and weathering resistance
- Outstanding resistance against battery acid, diesel, various oils, engine coolant and window washer fluids
- Resistance against humidity, petrol and brake fluids
- Flame retardant
- Soldering iron resistant
- Easy to strip and process

Application

Screened cable for power transmission in hybrid and electrical vehicles.

Standards

Conductor	General
ISO 6722-1, ISO 19642-9 (ISO structure C)	ISO 6722-1, ISO 19642-9 class D, thin-wall
DIN EN 13602, Cu-ETPI-A (CW003A)	

For further technical details please refer to our data sheet STD 859519.

RADOX[®] screened FLEX single core cable (FHLR4GC13X)

Extract from our delivery programme

Cross section	Conductor				Cable				
	Nominal mm ²	Number of ind. wires guide value	Dia. of ind. wires max. mm	Diameter max. mm	Resistance at 20 °C max. Ω/km	Diameter of insulation nom. mm	Diameter of screen max. mm	Overall-diameter nom. mm	Z _T at 30 MHz nom. mΩ/m
16	490	0.21	5.4	1.16	6.85	8.0	9.3 ± 0.3	60	22.8
25	760	0.21	7.1	0.743	8.35	9.5	11.0 ± 0.3	50	32.2
35	1064	0.21	8.2	0.527	9.90	11.2	12.9 ± 0.3	40	46.1
50	1520	0.21	9.9	0.368	11.70	13.0	14.9 ± 0.3	30	63.1
70	1427	0.26	11.6	0.259	14.00	15.2	17.0 ± 0.4	30	85.2
95	1936	0.26	13.3	0.196	16.20	17.7	19.5 ± 0.4	20	113.7
120	2450	0.26	15.1	0.153	19.10	20.7	22.6 ± 0.4	20	143.5

Datasheet STD 859519

RADOX[®] screened multi core cable (FHLR91XC13X and FHLR4GC13X)



Number of conductors	2 to 5
Cross section	1.5 to 70 mm ²
Voltage rating	1000 V AC/1500 V DC
Temperature range	-55 to +150 °C (3000 h)
Min. bending radius	4 × cable dia.

Composition of cable

1. Conductor	stranded bare copper
2. Insulation	RADOX 155S (91X) or RADOX 155 (4G)
3. EMC screen	tin plated copper braid optimised
4. Tape	plastic or aluminium screen (optional)
5. Sheath	RADOX Elastomer S (13X), colour: orange

Characteristics and specialities

- Excellent high and low temperature resistance
- Ozone and weathering resistance
- Outstanding resistance against battery acid, diesel, various oils, engine coolant and window washer fluids
- Resistance against humidity, petrol and brake fluids
- Flame retardant
- Soldering iron resistant
- Easy to strip and process

Application

Screened power cable for use in hybrid and electrical vehicles.

Standards

Conductor	General
ISO 6722	ISO 6722, ISO 19642-9 class D, thin-wall
DIN EN 13602, Cu-ETPI-A (CW003A)	

For further technical details please refer to our data sheet STD 806686.

RADOX[®] screened multi core cable (FHLR91XC13X and FHLR4GC13X)

Extract from our delivery programme

Cable type	Conductor			Cores	Cable				
	Nominal n × mm ²	Number of ind. wires guide value	Dia. of ind. wires max. mm		Conductor diameter max. mm	Diameter of cores nom. mm	Resistance at 20 °C max. Ω/km	Diameter of screen max. mm	Overall-diameter nom. mm
2 × 2.5	50	0.26	2.2	2.85	798	6.3	8.4 ± 0.3	50	12.0
2 × 4	56	0.31	2.6	3.55	4.95	7.8	10.2 ± 0.3	30	18.2
2 × 6	84	0.31	3.1	4.15	3.30	9.0	11.0 ± 0.35	50	22.5
2 × 8	60	0.41	3.8	5.05	2.50	11.0	12.8 ± 0.4	40	31.1
2 × 10	78	0.41	4.3	5.75	1.91	12.4	14.4 ± 0.4	40	40.5
3 × 2.5	50	0.26	2.2	2.85	798	6.8	8.4 ± 0.3	70	14.4
3 × 4	56	0.31	2.6	3.55	4.95	8.4	10.1 ± 0.4	80	21.0
3 × 6	84	0.31	3.1	4.15	3.30	10.0	12.4 ± 0.4	70	32.2
3 × 10	78	0.41	4.3	5.75	1.91	13.4	15.8 ± 0.5	30	49.6
3 × 16	126	0.41	5.4	6.90	1.21	16.0	18.5 ± 0.5	30	75.1
3 × 35	273	0.41	7.9	9.70	0.554	22.5	24.9 ± 0.5	140	148.8
4 × 2.5	50	0.26	2.2	2.85	798	7.6	9.2 ± 0.3	40	18.1
4 × 4	56	0.31	2.6	3.55	4.95	9.3	11.3 ± 0.4	50	26.5
4 × 6	84	0.31	3.1	4.15	3.30	11.0	12.9 ± 0.4	50	37.6
4 × 10	78	0.41	4.3	5.75	1.91	15.0	17.1 ± 0.5	40	64.7
5 × 4	56	0.31	2.6	3.55	4.95	10.8	13.3 ± 0.4	70	36.2
5 × 6	84	0.31	3.1	4.15	3.30	12.4	14.4 ± 0.4	30	47.0

Datasheet TD 806686

RADOX[®] sensor cables

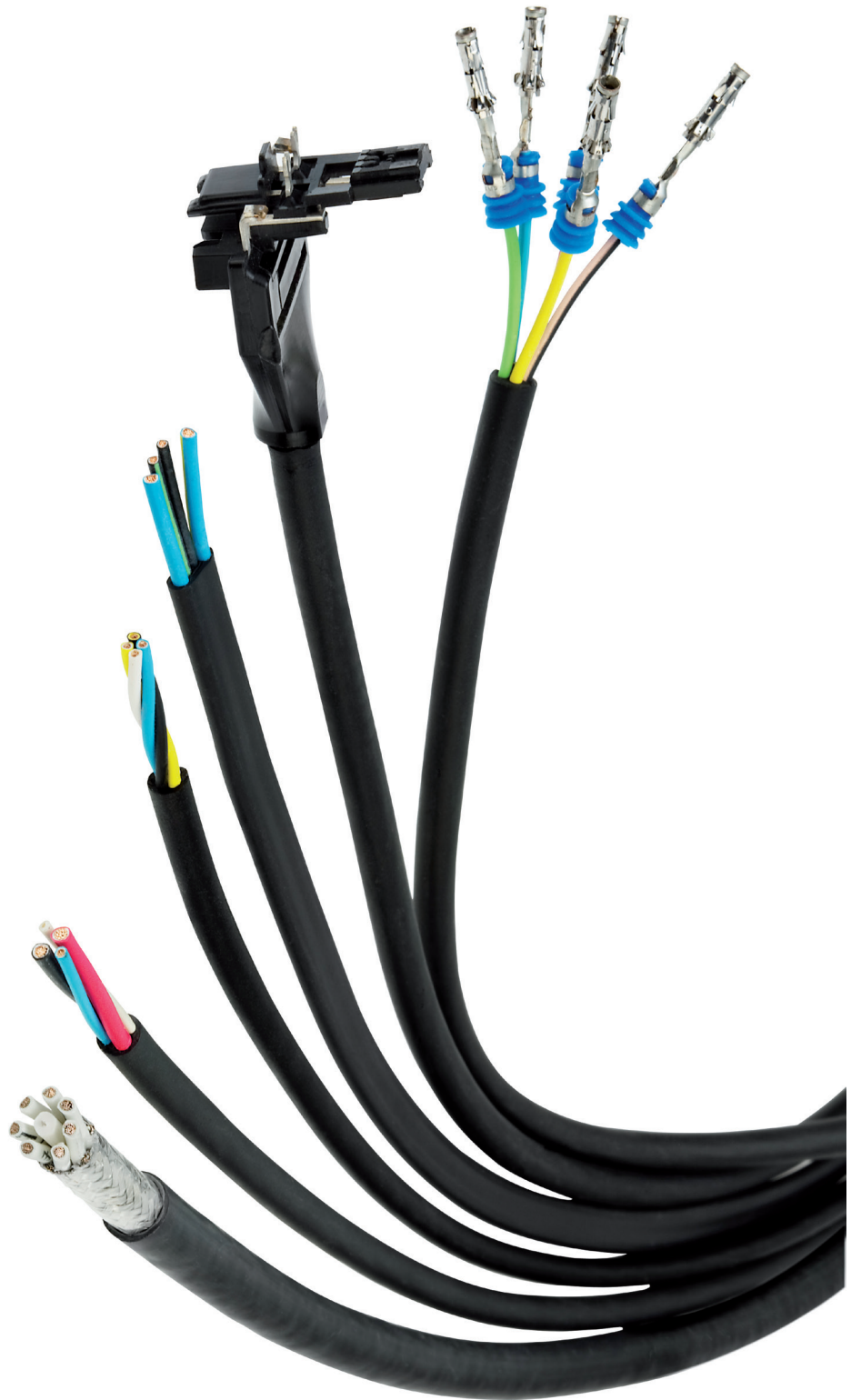

Sensor cables for road vehicles: Resistant to low and high temperatures, flame retardant, flexible and media resistant, customer specific designs.

Pressure, knock and temperature sensors are standard today, and sensors for seatbelt tighteners, automatic transmissions, diesel pumps, ABS/EPS systems, speed monitoring plus other applications are an increasing demand. It must be ensured that critical electrical circuits will perform faultlessly under the most adverse conditions.

Electrical systems for fan motors, water pumps, power steering, brakes and accelerators are increasingly replacing V-belts, various hydraulic motors and mechanical actuators. Sensor cables serve for controlling the electronics and supplying power to the electric motors.

General features

- Temperature range –55 to +150 °C
- Resistant to motor oils, fuels, hydrolysis
- Electron beam cross-linked RADOX insulation does not melt or flow at high temperatures
- Usable in automated processing
- Resistant to potting or overmoulding
- Compact and flexible

RADOX[®] sensor cables

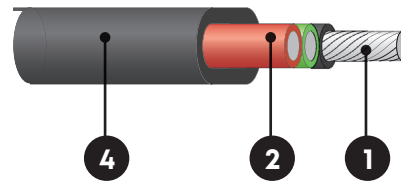
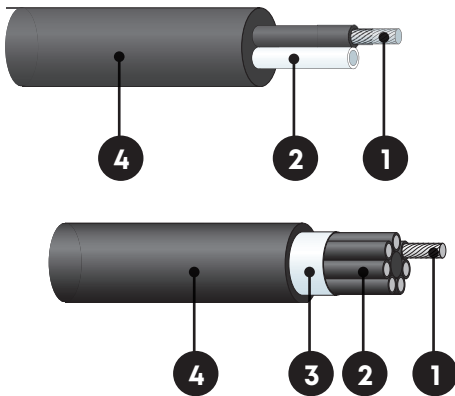

Number of conductors	1 to 50
Cross section	0.14 to 6 mm ²
Voltage rating	60 to 600 V DC
Temperature range	(-55) -40 to +150 °C (3000 h)

Composition of cable

- | | |
|---------------|--------------------------------------|
| 1. Conductor | stranded tinned or bare copper |
| 2. Insulation | various RADOX, fluoropolymers |
| 3. EMC screen | copper braiding or aluminium tape |
| 4. Jacket | various RADOX, TPU or fluoropolymers |

Characteristics and specialities

- High and low temperature resistance
- Ozone and weathering resistance
- Resistant to pressure at high temperature
- Resistant to motor oils, fuels and hydrolysis
- Flame retardant
- High abrasion resistance
- Easy to strip and process

Application

Sensor cables for use in road vehicle applications.

Standards

Conductor	General
ISO 6722	ISO 19642
DIN EN 13602, Cu-ETPI-A (CW003A)	ADR approved

For further technical details please refer to our data sheet.

RADOX[®] sensor cables

Customised cables to your requirements

- Round or flat cable?
- EMC shielding necessary?
- What degree of flexibility is required?
- Special temperature requirements?
- Special requirements for voltage rating, impedance, attenuation?
- Special chemical or environmental concerns?
- Potting or overmoulding?
- Special requirements on processing (crimping, welding, ultrasonic welding, etc.)?
- Approvals?

Our leads

single-coloured or two-coloured



Lead type	Temperature range	Cross section	Designation
	3000 h	mm ²	
RADOX 155S RW	-55 to +150 °C	0.14 to 1	Following „ultra thin-wall“ according to ISO 6722, excellent media resistance, for applications where a small diameter is required
RADOX 155S FLR	-55 to +150 °C	0.35 to 6	„Thin-wall“ according to ISO 6722, excellent media resistance, for standard applications
PE-X	-40 to +125 °C	0.35 to 1	Databus cable with 110/120 Ω impedance
ETFE FLR	-55 to +200 °C	0.35 to 6	„Thin-wall“ according to ISO 6722, excellent media resistance, such as hot oil

Our jacket materials

Jacket material	Temperature range	Electron beam cross-linked	Mechanical resistance	Flexibility	Media resistance
	3000 h				
RADOX Elastomer S	-70 to +150 °C	yes	very good	excellent	excellent
RADOX 155	-55 to +150 °C	yes	good	good	good
TPU	-40 to +125 °C	no	very good	excellent	good

RADOX® databus cables

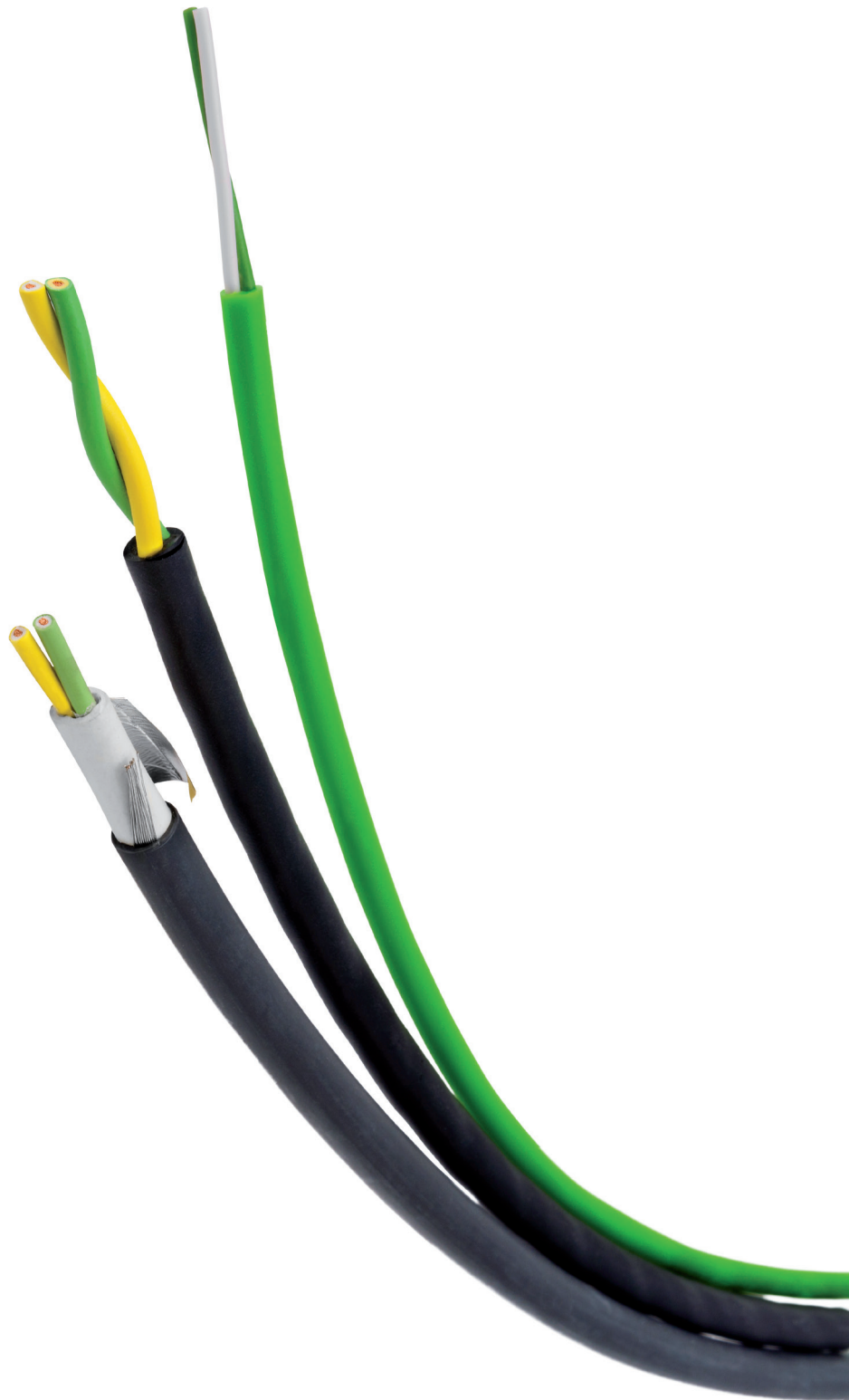

Optimum protection of sensitive data with RADOX

The continuous growth in the application of electronic systems in road vehicles requires reliable databus cables for transmitting information at high frequencies. CAN, LIN, MOST, FlexRay and Ethernet applications have become part of the modern on-board network structures inside vehicles.

HUBER+SUHNER combines its know-how in data communications with electron beam cross-linked materials technology to offer cables meeting specifications such as SAE J1939-11, -15 or ISO 11898-2 (CAN).

Using their electron beam cross-linked RADOX insulation, the cables offer high thermal pressure resistance, resistance to fluids and good abrasion resistance, and they can be applied across a wide temperature range.

General features

- Excellent dielectric performance
- Flame retardant insulation, neither melting nor flowing when exposed to high temperatures
- Operating temperature -55 to +150 °C
- Outstanding data transmission performance
- Optimal protection using RADOX insulation
- Application is possible in engine compartments

RADOX® databus cables

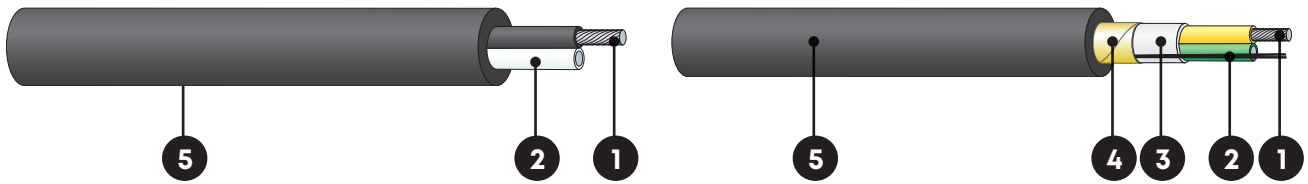

Number of conductors	2 to 4
Cross section	0.35 to 0.75 mm ²
Voltage rating	60 V DC
Temperature range	(-55) -40 to +125 °C/+150 °C(3000 h)
Min. bending radius	4 × cable dia.

Composition of cable

1. Conductor	stranded tinned or bare copper
2. Insulation	various RADOX insulation materials or PE-X
3. Sheath	various RADOX jacket materials
4. Screen	plastic laminated aluminium tape and drain wire
5. Sheath	various RADOX jacket materials or TPU

Characteristics and specialities

- Excellent dielectric performance
- Outstanding data transmission performance
- Possible application in engine compartments
- High and low temperature resistance
- Flame retardant

Application

Databus cable for transmitting information at high frequencies in road vehicles.

Standards

Conductor	General
ISO 6722	ISO 6722, ISO 14642 class C and D
DIN EN 13602, Cu-ETP1-A (CW003A)	SAE J1939-11/-15

For further technical details please refer to our data sheet.

RADOX[®] databus cables

Extract from our delivery programme

Cable types

Cross section	Conductor			Core		Screen	Outside diameter
	mm ²	Construction* n × mm	Diameter. max. mm	Resistance at 20 °C max. Ω/km	Wall thickness min. mm	Diameter mm	Aluminium tape
2 × 0.35	7 × 0.26	0.77	52.0	0.66	2.1	no	5.6
2 × 0.50	19 × 0.18	0.89	37.1	0.80	2.5	no	6.2
2 × 0.75	19 × 0.22	1.10	24.7	0.95	3.0	no	7.2
2 × 0.35	7 × 0.26	0.77	52.0	0.66	2.1	yes	8.0
2 × 0.50	19 × 0.18	0.89	37.1	0.80	2.5	yes	8.3
2 × 0.75	19 × 0.22	1.10	24.7	0.95	3.0	yes	10.7

Jacket materials

Jacket material	Temperature range	Electron beam cross-linked	Flexibility	Media resistance
	3000 h			
RADOX Elastomer S	-70 to +150 °C	yes	excellent	excellent
RADOX 155	-55 to +150 °C	yes	good	good
TPU	-40 to +125 °C	no	excellent	good

Automotive cable systems

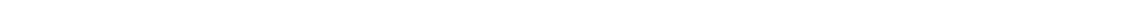
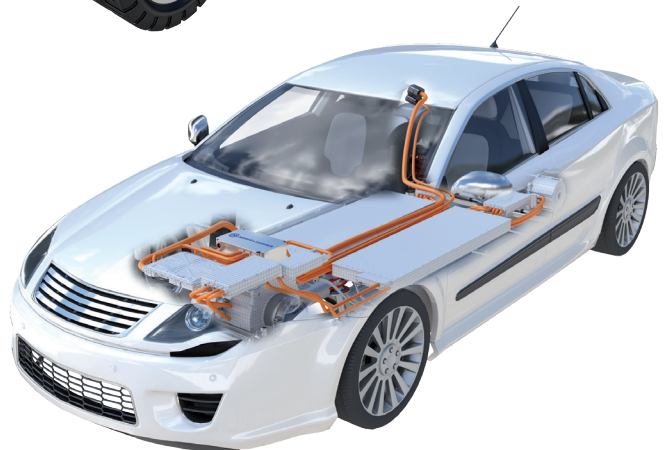

The quality of the cabling throughout a vehicle plays a crucial role in transmitting and protecting power as it is stored in the vehicle. The cables need to be able to resist mechanical abrasion, harsh environmental conditions, moisture, temperature, aggressive fluids, as well as handle voltages up to 1000VAC/1500VDC. HUBER+SUHNER wires & cables and cable systems are designed with these challenges in mind.

When it comes to EV cable systems in the automotive sector, the main considerations are: high level of safety, reasonable costs and the correct approvals. Our in-house engineers are well experienced in the EV sector and never lose sight of the bigger picture. As a result, HUBER+SUHNER delivers complete cable system solutions that meet required automotive standards, whilst also optimising the installation processes.

Engineers work closely with our customers, always taking the latest market requirements as a starting point. A wide variety of parts in our automotive product range e.g. 3-pole connector, are tailored to specific customers and specific applications. With our global presence and many years of high voltage experience, we support new products a smooth entry into the EV market.

Benefits of using HUBER+SUHNER cable systems:

- Safe and reliable connection
- Easy assembly, saving time and money
- A smooth and effective integration with HVDU solutions
- High current carrying capacity for higher loads
- High Ingress Protection (IP) for both solid objects and liquids
- High voltage testing & validation services, both internal and external – to guarantee high product quality
- Possibility of joint development projects, allowing access to specialised engineering resources as well as RADOX technology

mHVDU – standard modular HVDU	46
chVDU – customised HVDU	48
RADOX® EV-C cable system	50
Cable assembly	53
3 pole connector	54

mHVDU – standard modular HVDU

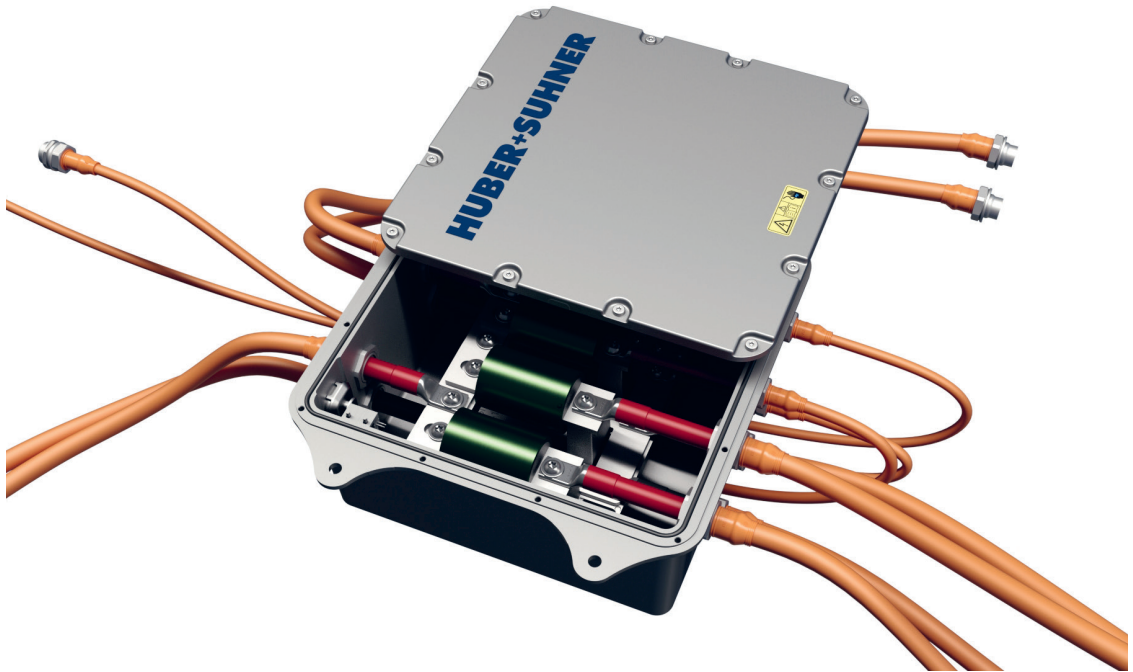

Applications

- Standard product solution
- Finalized and available
- Composed of standardized components

Benefits

- Scalability of in- and outputs and fuses (variant configurator)
- Standardized process and short lead times
- Ideal for prototypes/samples in harsh environments
- Space, weight and cost saving
- Fully validated
- Harmonized with H+S product portfolio (AWC + ACS)

mHVDU – standard modular HVDU

Technical data

Electrial specifications	Modular High Voltage Distribution Unit
Voltage rating	500 V dc / 800 V dc
Current rating	up to 650 A
Test voltage	2,15 kV dc
Screen resistance	< 9 m Ω (H+S EV-C connection)
Insulation resistance (1000 Vdc, 60 sec., 85 °C)	> 50 M Ω
EMC protection	ECE-R10 (E1 certificate) acc. CISPR25 - 2016 6.3-5
Channels (outputs fused only)	Input 2+1 / Output 6
HVIL	(passive) HV-interlock
Degree of customization	Scheme based configuration of fuses

Mechanical data	Modular
Vibration and shock resistance	ISO 16750-3 (Profile VII.)
Housing material	Aluminium die-cast
Max. dimensions (length, width, height)	325 mm x 325 mm x 144 mm
Cable connection position	in line from side-to-side
Waterproof pressure equalizing valve	yes

Environmental Data	Modular
Temperature range (ambient)	-40 to +85 °C
relative humidity	0% - 95%
Altitude	4.000 m above sea level
Ingress Protection	IP6K9K / IP67
Corrosion resistance	ISO 16750-4 (incl. VDA 233-102)

Available for	Modular
H+S cable cross section	4 mm ² to 95 mm ²
Application (multifunctional)	commercial-, special- and industrial electric vehicles (incl. passenger cars)
APQP process step	A-, B-, C-, (D-) sample, series

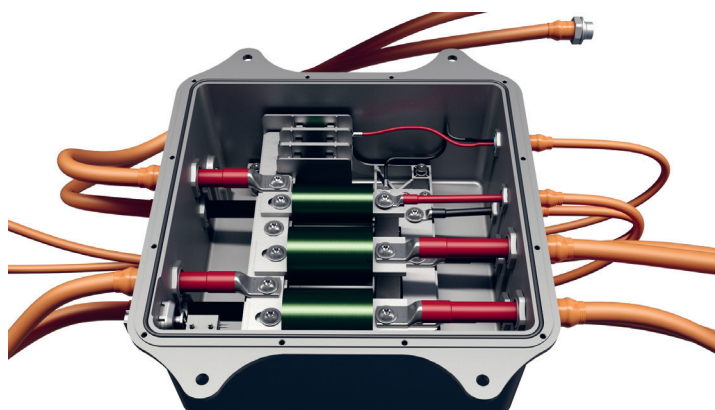

cHVDU – customised HVDU



Applications

- Fully customised product solution
- High flexibility and choice of electrical components

Benefits

- No limitations to size and components
- All relevant components available (capacitors, contactors, etc.)
- Suitable in harsh environments (temperature, EMC)
- Space and weight saving
- Access to broad and long-term experience of HUBER+SUHNER
- Automotive certified components
- Harmonized with other HUBER+SUHNER product portfolio

cHVDU – customised HVDU

Technical data

Electrial specifications	Customised
Voltage rating	up to 1000 VDC
Current rating – standard configuration	customer specific
Test voltage	2,150 VDC
Screen resistance	< 9 mΩ
Insulation resistance (1000 Vdc, 60 sec., 85 °C)	> 50 MΩ
Altitude	4000 m above sea level
EMC protection	LV123 and LV215
Channels (outputs fused only)	variable
HVIL	(passive) HV-interlock
Degree of customization	capacitors, contactors, relays, etc.

Mechanical data	Customised
Vibration and shock resistance	ISO 16750-3
Housing material	aluminium die-cast, aluminium alloy milled
Max. dimensions (length, width, height)	customer specific
Cable connection position	variable
Waterproof pressure equalizing membrane	yes

Environmental data	Customised
Temperature range (ambient)	-40 to +85 °C
Ingress protection	IP6K9K / IP67
Corrosion resistance	ISO 16750-4

Available for	Customised
H+S cable cross section	2.5 to 95 mm ²
Application (multifunctional)	commercial-, special- and industrial electric vehicles (incl. passenger cars)
Recommended APQP process step	B-, C-, (D-) sample

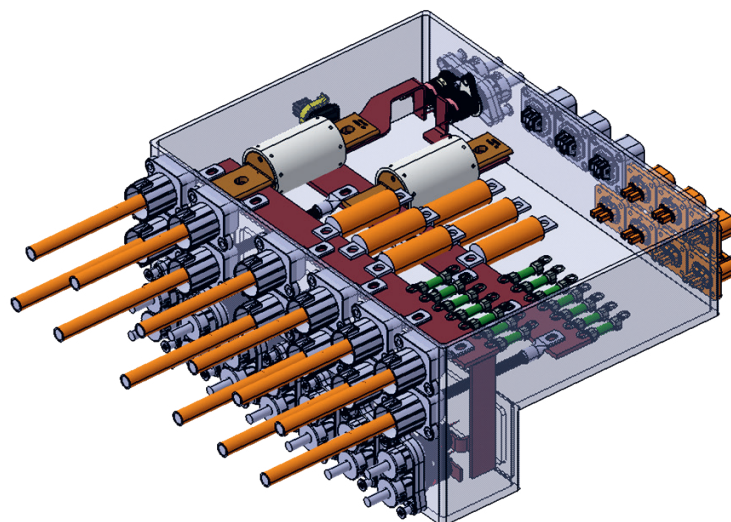

RADOX® EV-C cable system



High Voltage cables in hybrid and electric vehicles move power to and from the battery and various systems throughout the vehicle. Managing and keeping these cables in place over the life of the vehicle and through a range of driving conditions is very critical.

High voltage automotive connection systems must stand up to wide temperature fluctuations, vibration and mechanical impact to secure and protect high voltage cables and components running throughout the vehicle. High performance electrical insulation, EMI protection and corrosion resistance are also important properties for this critical application.

Merging RADOX cable technology with a reputation for legendary reliability with innovative connectivity solution RADOX EV-C, HUBER+SUHNER is able to provide customers with an end-to-end offering.

The RADOX EV-C cable feed-cable gland, provides a barrier to moisture and debris, as well as retains cables in place. The connection is designed for high current carrying capability in harsh environments and with minimal space requirements. This robust solution, validated internally and externally for automotive high voltage applications, brings added reliability and durability, great performance and ease of assembling.

RADOX® EV-C Single-Core



Benefits

- High ampacity of conductor and shielding
- Compact design with reliable connections and seals
- True 360° screen connection
- Wide shock and vibration resistance
- High temperature range (-40 °C to 140 °C)
- Proven protection against environmental factors IP67 and IP6K9K
- Wide range of cable cross sections — from 16 to 120 mm²

Technical data

Electrical Data	
Voltage rating	1000 V DC
Current carrying capacity	450A (95 mm ²) at 85°C
Screen resistance	< 7 mΩ

Mechanical data	
Cross section	Single-Core: 16, 25, 35, 50, 70, 95, 120 mm ²

Environmental data	
Ambient temperature	-40°C to +140°C
IP Rating	IP6K9K / IP67

RADOX® EV-C Multi-Core



Benefits

- The same interface as single-core version
- Compact design with reliable connections and seals
- High shock and vibration resistance
- Wide temperature range (-40 to 140°C)
- Proven protection against environmental factors IP67 and IP6K9K
- Available cable cross sections – 2x4 , 2x6 and 4x10 mm² (other sizes upon request)

Technical data

Electrical Data	
Voltage rating	2 × 4 mm ² , 700V DC 2 × 6 mm ² , 800V DC 4 × 10 mm ² , 850V DC
Current carrying capacity	88 A / 105 A / 230 A @ 85°C
Screen resistance	< 7 mΩ

Mechanical data	
Cross section	Multi-Core: 2 × 4, 2 × 6 and 4 × 10 mm ²

Environmental data	
Ambient temperature	-40°C to +140°C
IP Rating	IP6K9K / IP67

Cable assembly



HUBER+SUHNER has provided Automotive industry with high-quality custom cable assemblies, wire harnesses and high voltage sub-assemblies since decades. Thanks to RADOX® technology, cable assemblies are extremely durable and able to withstand the conditions of heavy duty applications.

Benefits

- High adaptability (turnkey or custom-built solutions)
- Very fast sample preparation for prototype builds as well as series
- Accelerated homologation process (assembly with RADOX EV-C is already validated by independent laboratory)
- Long operation time under harsh environments
- Possible system usage without corrugated tubes

3 pole connector



Applications

HUBER+SUHNER develops complex and innovative cable systems according to customer requirements.

Benefits

- Assembly of HV harnesses with our cables for specific applications – according to customer requirements
- Compact design, for easy integration into Customer HV system
- High electrical loads permissible
- High shock and vibration resistance
- Proven protection against environmental factors
- Reliable connections and seals

Technical and delivery information

In this chapter you find the following, additional and useful information about automotive wire and cable:

- RADOX® details and advantages
- Temperature classes
- Current carrying capacity
- Delivery spools

RADOX details and advantages	56
Temperature classes	57
Current carrying capacity	58
Delivery spools	68

RADOX® – An unique technology meets wider applications

What is RADOX?

RADOX represents electron beam cross-linked insulating materials developed by HUBER+SUHNER. The RADOX insulations offer excellent resistance to thermal, chemical, electrical and mechanical loads. Thanks to reduced wall thicknesses, it also saves weight and space. RADOX materials enable solutions to be customised to specific applications.

RADOX does not melt!

Thermoplastic insulation materials are sometimes used for automotive wiring. Products such as PVC, PP, PE, PA, TPE and Fluoropolymers are used. These materials all have a melting point and at certain temperature peaks in specific applications they eventually melt with the risk of creating a short circuit. RADOX does not melt and therefore provides an extra safety margin for automotive applications.

RADOX withstands temperature peaks!

Since RADOX is not melting, it will withstand temperature peaks above the defined temperature range. A typical automotive RADOX cable is specified for applications between -40 and $+150$ °C based on a lifetime of 3000 h. Even at higher temperature peaks, RADOX does not melt. There is a rule of thumb that states, $+10$ °C temperature increase reduces lifetime by half (160 °C/1500 h, 170 °C/750 h, etc.), the converse also applies.

RADOX extends lifetime at lower temperature!

In general automotive cables are defined with different temperature ratings based on 3000 h. This makes sense in most of the cases since 3000 h corresponds to 150 000 km lifetime for a car (at 50 km/h average speed). If any application asks for a longer lifetime, especially with trucks and buses, RADOX is the best choice. By using a 150 °C rated RADOX cable at 120 °C, this will extend lifetime to 24 000 h or 1 200 000 km.

RADOX withstands low temperatures!

Automotive specifications define clear temperature ranges. These ranges often start from -40 °C and go up to 85, 100, 125, 150, 175 °C, etc. The range is described as class B, C, D or T2, T3 and T4 and so on. RADOX can do better than that! REMS will withstand -70 °C, RADOX 155S and 155 at least -55 °C. This creates more possibilities where for example a standard PVC can not do the job.

Temperature classes for cables

Automotive specifications define clear temperature ranges. These ranges often start from $-40\text{ }^{\circ}\text{C}$ and go up to 85, 100, 125, 150, 175 $^{\circ}\text{C}$, etc. The range is described as class A, B, C, D, E, F, G and H or T1, T2, T3, T4, T5 and T6. These temperature classes are defined according to ISO 6722, the ratings are valid for 3000 hours.

Class rating	Temperature	Materials
H	-40 to $+250\text{ }^{\circ}\text{C}$	fluoropolymers
G	-40 to $+225\text{ }^{\circ}\text{C}$	fluoropolymers
F (6)	-40 to $+200\text{ }^{\circ}\text{C}$	fluoropolymers, silicone
E (5)	-40 to $+175\text{ }^{\circ}\text{C}$	fluoropolymers, silicone
D (4)	-40 to $+150\text{ }^{\circ}\text{C}$	fluoropolymers, Polyesters, RADOX®
C (3)	-40 to $+125\text{ }^{\circ}\text{C}$	PE-X, TPE, PVC-X, RADOX
B (2)	-40 to $+100\text{ }^{\circ}\text{C}$	PE-X, TPE, PVC
A (1)	-40 to $+85\text{ }^{\circ}\text{C}$	PVC

Current carrying capacity

RADOX® 155 and REMS battery cables and RADOX 155 SFLR single core cables

Standard conditions for current rating

The tabled values for the current rating were calculated according to IEC 60287 for the following standard conditions:

- Continuous operation
- Single circuit for 3-phase current, single conductor for 1-phase current
- 30 °C ambient temperature and sufficiently large and ventilated spaces, whose ambient temperature is not appreciably increased by the heat coming from the cables
- 150 °C conductor temperature
- ISO 6722: 3000 h/150 °C winding test
- Frequency from 0 Hz (DC) up to 200 Hz (AC)

Installation in air, unrestricted heat dissipation, means that the following installation conditions are observed:

- Distance of the cables from the wall, from the floor, from the ceiling \geq cable diameter
- Distance between two adjacent power circuits $\geq 2 \times$ cable diameter
- Vertical distance between power circuits laid one upon another for individual cables $\geq 2 \times$ cable diameter
for layers of cables > 200 mm
- Perforated tray with a perforation > 30 % of the total surface

Open trays are continuous supports with vertical sides, but without cover. A possible perforation accounts for ≤ 30 % of the total surface.

Closed ducts are entirely closed. Pipes belong to this category also. The max. filling degree is 70 %.

Lifetime expectation

If cross-linked wires are used at higher temperatures than indicated by the temperature rating in ISO 6722, the lifetime is reduced accordingly. Analogical, the lifetime will increase at lower temperature. RADOX 155 for example has a life span of 3000 h at a conductor temperature of +150 °C. When it is used at different temperature, lifetime expectations are shown as follows:

Example on basis

RADOX 155, REMS and RADOX 155 SFLR

180 °C	375 h
170 °C	750 h
160 °C	1500 h
150 °C	3000 h
140 °C	6000 h
130 °C	12000 h
120 °C	24000 h

Current carrying capacity

RADOX® 155 and REMS battery cables and RADOX 155 SFLR single core cables

Current rating under service conditions

$$I = I_N \cdot f_1 \cdot f_2 \cdot f_3 \cdot f_4$$

I [A] current rating for continuous operation under service conditions

I_N [A] current rating for continuous operation under standard conditions

f_1 reduction factor for increased ambient temperature

f_2 conversion factor for deviated conductor temperature

f_3 reduction factor for multicore cables

f_4 reduction factor for increased frequency

Reduction factors for increased ambient temperature (f_1)

Ambient temp. °C	30	35	40	45	50	55	60	65	70	75	80	85	90	95	100	105	110	115
Reduction factor f_1	1	0.97	0.95	0.93	0.91	0.89	0.86	0.84	0.81	0.79	0.76	0.73	0.70	0.67	0.64	0.61	0.57	0.54

Reduction factors for different permissible conductor temperature (f_2)

Conductor temp. °C	180	170	160	150	140	130	120	110	100	90	80	70	60	50	40
Reduction factor f_2	1.09	1.07	1.04	1	0.96	0.91	0.85	0.79	0.72	0.67	0.56	0.47	0.37	0.27	0.16



Reduction factors for increased frequency (f_4)

Frequency Hz*	400	600	800	1000	2000	3000	4000	5000	10000
Copper conductor cross section mm ²	faktor f_4								
1.5	1	1	1	1	1	1	1	1	1
2.5	1	1	1	1	1	1	1	1	1
4	1	1	1	1	1	1	1	1	0.98
6	1	1	1	1	1	1	1	0.99	0.93
10	1	1	1	1	1	1	0.96	0.93	0.82
16	1	1	1	1	1	0.95	0.91	0.87	0.76
25	1	1	1	1	0.94	0.88	0.83	0.80	0.69
35	1	1	1	0.98	0.89	0.82	0.77	0.74	0.64
50	1	1	0.97	0.94	0.83	0.76	0.72	0.69	0.59
70	1	0.95	0.91	0.88	0.77	0.71	0.67	0.63	0.54
95	0.98	0.93	0.88	0.84	0.73	0.67	0.63	0.60	0.51
120	0.94	0.88	0.84	0.80	0.69	0.64	0.60	0.57	0.48
150	0.90	0.85	0.80	0.77	0.66	0.61	0.57	0.54	0.46

* We recommend that you use a special conductor design for frequencies > 800 Hz and cross sections > 25 mm² (waveguide design).

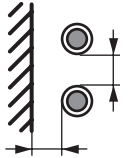

Current carrying capacity

RADOX® 155 and REMS battery cables

Installation method	Connecting lead in free air or perforated tray											
Number of simultaneous loaded conductors on each tray												
	1	2	3	4	6	8	10	16	20	4	6	
Reduction factor f_3	1	0.87	0.81	0.78	0.75	0.74	0.73	0.72	0.71	0.71	0.62	
Copper conductor cross section mm ²	Current carrying capacity A											
4	88	76	71	68	66	65	64	63	62	62	54	
6	113	98	92	88	85	84	83	81	80	80	70	
10	165	144	134	129	124	122	121	119	117	117	102	
16	222	193	180	173	166	164	162	160	157	157	137	
25	294	256	239	230	221	218	215	212	209	209	183	
35	370	321	299	288	277	273	270	266	262	262	229	
50	471	410	382	367	353	349	344	339	334	334	292	
70	592	515	480	462	444	438	432	427	421	421	367	
95	719	626	583	561	540	532	525	518	511	511	446	
120	840	731	680	655	630	622	613	605	596	596	521	
150	974	848	789	760	731	721	711	702	692	692	604	

Continuous current rating

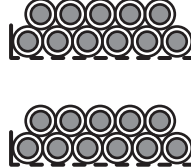

Conductor temperature +150 °C, ambient temperature +30 °C

															
8	10	16	20	4	6	8	10	16	20	4	6	8	10	16	20
0.57	0.53	0.47	0.45	0.67	0.59	0.54	0.50	0.45	0.43	0.71	0.58	0.52	0.48	0.41	0.38

50	47	41	39	59	52	47	44	39	38	62	51	46	42	36	33
65	60	53	51	76	67	61	57	51	49	80	66	59	54	46	43
94	88	78	74	111	97	89	83	74	71	117	96	86	79	68	63
126	118	104	100	149	131	120	111	100	95	157	129	115	106	91	84
168	156	138	133	197	174	159	147	133	127	209	171	153	141	121	112
211	196	174	166	248	218	200	185	166	159	262	214	192	177	151	140
269	250	221	212	316	278	254	236	212	203	334	273	245	226	193	179
338	214	278	267	397	349	320	296	267	255	421	344	308	284	243	225
410	381	338	324	482	424	388	360	324	309	511	417	374	345	295	273
479	445	395	378	563	496	454	420	378	361	596	487	437	403	344	319
555	516	458	438	653	575	526	487	438	419	692	565	507	468	399	370

Current carrying capacity

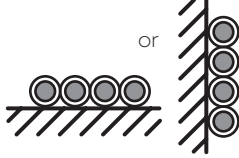
RADOX® 155 and REMS battery cables

Installation method	On floor or wall				Fixed on a ceiling or under floor							
Number of simultaneous loaded conductors on each tray												
	1	2	3	4	1	2	3	4	5	6	7	8
Reduction factor f_3	1	0.85	0.79	0.75	0.95	0.81	0.72	0.68	0.66	0.64	0.63	0.62
Copper conductor cross section mm ²	Current carrying capacity A											
4	79	67	62	59	75	64	57	53	52	50	49	49
6	100	85	79	75	95	81	72	68	66	64	63	62
10	148	126	117	111	140	120	106	101	98	95	93	92
16	200	170	158	150	190	162	144	136	132	128	126	124
25	267	227	211	200	253	216	192	181	176	171	168	165
35	337	287	266	253	320	273	243	229	223	216	212	209
50	431	366	340	323	409	349	310	293	284	276	271	267
70	544	462	430	408	517	441	392	370	359	348	343	337
95	662	562	523	496	629	536	476	450	437	423	417	410
120	775	659	612	581	736	628	558	527	511	496	488	480
150	901	766	712	676	856	730	649	613	595	577	568	559

Continuous current rating

Conductor temperature +150 °C, ambient temperature +30 °C

In conduit, in a void or in a pipe

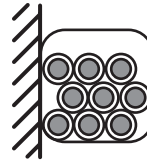
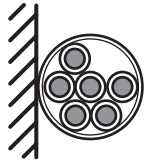

≥ 9	1	2	3	4	5	6	7	8	9	10	12	14	16	20
0.61	1	0.80	0.70	0.65	0.60	0.57	0.54	0.52	0.50	0.48	0.45	0.43	0.41	0.38

48	62	63	55	51	47	45	42	41	39	38	35	34	32	30
61	81	65	57	53	48	46	44	42	40	39	36	35	33	31
90	110	88	77	71	66	63	59	57	55	53	49	47	45	42
122	151	121	106	98	91	86	82	79	76	73	68	65	62	57
163	202	162	141	131	121	115	109	105	101	97	91	87	83	77
206	251	200	175	163	150	143	135	130	125	120	113	108	103	95
263	315	252	221	205	189	180	170	164	158	151	142	136	129	120
332	395	316	276	257	237	225	213	205	197	190	178	170	162	150
404	490	392	343	318	294	279	264	255	245	235	220	211	201	186
473	566	453	396	368	339	323	306	294	283	272	255	243	232	215
550	654	523	458	425	393	373	353	340	327	315	294	281	268	249

Current carrying capacity

RADOX® 155S FLR single core cables

Installation method	Connecting lead in free air or perforated tray										
Number of simultaneous loaded conductors on each tray											
	1	2	3	4	6	8	10	16	20	4	6
Reduction factor f_3	1	0.87	0.81	0.78	0.75	0.74	0.73	0.72	0.71	0.71	0.62
Copper conductor cross section mm ²	Current carrying capacity A										
0.35	18	16.0	14.9	14.4	13.8	13.6	13.4	13.3	13.1	13.1	11.4
0.50	24	21.0	19.6	18.9	18.1	17.9	17.7	17.4	17.2	17.2	15.0
0.75	31	27	25	24	23	23	23	22	22	22	19
1	37	32	30	29	28	27	27	27	26	26	23
1.5	47	41	38	37	36	35	35	34	34	34	29
2.5	65	56	52	50	48	48	47	47	46	46	40
4	88	76	71	68	66	65	64	63	62	62	54
6	113	98	92	88	85	84	83	81	80	80	70

Continuous current rating

Conductor temperature +150 °C, ambient temperature +30 °C



8	10	16	20	4	6	8	10	16	20	4	6	8	10	16	20
0.57	0.53	0.47	0.45	0.67	0.59	0.54	0.50	0.45	0.43	0.71	0.58	0.52	0.48	0.41	0.38

10.5	9.7	8.6	8.3	12.3	10.9	9.9	9.2	8.3	7.9	13.1	10.7	9.6	8.8	7.5	7.0
13.8	12.8	11.3	10.9	16.2	14.3	13.0	12.1	10.9	10.4	17.2	14.0	12.6	11.6	9.9	9.2
18	17	15	14	21	18	17	16	14	13	22	18	16	15	13	12
21	20	17	17	25	22	20	18	17	16	26	21	19	18	15	14
27	25	22	21	32	28	26	24	21	20	34	27	25	23	19	18
37	34	30	29	43	38	35	32	29	28	46	38	34	31	27	25
50	47	41	39	59	52	47	44	39	38	62	51	46	42	36	33
65	60	53	51	76	67	61	57	51	49	80	66	59	54	46	43

Current carrying capacity

RADOX® 155 and REMS battery cables

Installation method	On floor or wall				Fixed on a ceiling or under floor							
Number of simultaneous loaded conductors on each tray												
	1	2	3	4	1	2	3	4	5	6	7	8
Reduction factor f_3	1	0.85	0.79	0.75	0.95	0.81	0.72	0.68	0.66	0.64	0.63	0.62
Copper conductor cross section mm ²	Current carrying capacity A											
0.35	15	12.7	11.8	11.2	14.2	12.1	10.8	10.2	9.9	9.6	9.4	9.3
0.50	20	16.6	15.5	14.7	18.6	15.9	14.1	13.3	12.9	12.5	12.3	12.1
0.75	27	23	21	20	25	22	19	18	18	17	17	16
1	31	27	25	23	30	25	22	21	21	20	20	19
1.5	39	33	31	29	37	32	28	27	26	25	25	24
2.5	55	47	44	42	53	45	40	38	37	35	35	34
4	76	65	60	57	72	62	55	52	50	49	48	47
6	100	85	79	75	95	81	72	68	66	64	63	62

Continuous current rating

Conductor temperature +150 °C, ambient temperature +30 °C

In conduit, in a void or in a pipe

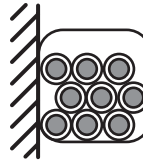
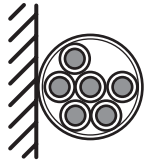

≥ 9	1	2	3	4	5	6	7	8	9	10	12	14	16	20
0.61	1	0.80	0.70	0.65	0.60	0.57	0.54	0.52	0.50	0.48	0.45	0.43	0.41	0.38

9.1	12.0	12.0	10.5	9.7	9.0	8.5	8.1	7.8	7.5	7.2	6.7	6.4	6.1	5.7
11.9	17.0	13.8	12.1	11.2	10.3	9.8	9.3	9.0	8.6	8.3	7.7	7.4	7.1	6.5
16	23	18	16	15	14	13	12	12	12	11	10	10	9	9
19	28	22	19	18	17	16	15	14	14	13	12	12	11	11
24	35	28	24	23	21	20	19	18	17	17	16	15	14	13
34	45	36	32	29	27	26	24	23	23	22	20	19	18	17
46	65	52	45	42	39	37	35	34	32	31	29	28	27	25
61	81	65	57	53	48	46	44	42	40	39	36	35	33	31

Delivery spools

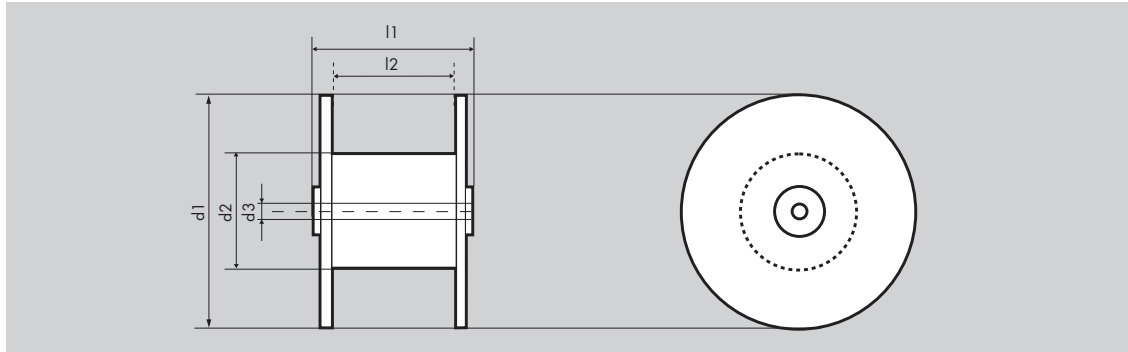

	Spool HS 150	Spool HS 151	Spool HS 200	Spool HS400	Spool HS 401	Spool HS 600
						
d 1	150	150	195	395	395	595
d 2	65	65	100	180	180	350
d 3	60	60	60	60	60	80
l 1	76	166	250	185	280	500
l 2	70	160	210	145	240	430
Tara kg	0.095	0.135	0.480	1.475	1.645	7.460

Cable Ø mm	Cable length per delivery m					
1	804	1'837	3'698	11'263	18'642	62'553
2	201	459	924	2'816	4'661	15'638
3	89	204	411	1'251	2'071	6'950
4	50	115	231	704	1'165	3'910
5	32	73	148	451	746	2'502
6	22	51	103	313	518	1'738
7	16	37	75	230	380	1'277
8	13	29	58	176	291	977
9	10	23	46	139	230	772
10	8	18	37	113	186	626
11	7	15	31	93	154	517
12	6	13	26	78	129	434
13	5	11	22	67	110	370
14	4	9	19	57	95	319
15	4	8	16	50	83	278
16	3	7	14	44	73	244
17	3	6	13	39	65	216
18	2	6	11	35	58	193
19	2	5	10	31	52	173
20		5	9	28	47	156
21		4	8	26	42	142
22		4	8	23	39	129
23		3	7	21	35	118
24		3	6	20	32	109

d1 flange diameter (mm), d2 core diameter (mm), d3 drill hole diameter (mm)
 l1 external width (mm)
 l2 reel width (mm)

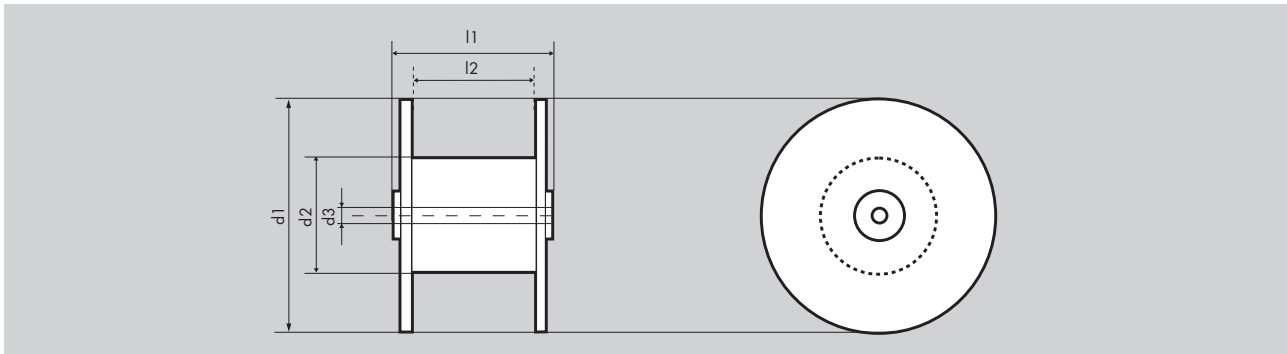

	Spool HS 601	Spool HS 800	Spool HS 1000	Spool HS 1200	Reusable NPS coil 250 x 400 (CK2)	Reusable NPS coil 400 x 400 (CK4)
						
d 1	595	795	1000	1190	400	400
d 2	250	450	500	600	208 to 260	176 to 260
d 3	80	80	80	80	80	80
l 1	500	750	800	790	313	463
l 2	430	620	660	650	250	400
Tara kg	7150	18.875	31.000	64.200	2.4	2.7

Cable Ø mm	Cable length per delivery m				For details about length, instruction manual and accessories ask for separate documentation.
1	78'763	167'325	311'018	431'319	
2	19'691	41'831	77'754	107'830	
3	8'751	18'592	34'558	47'924	
4	4'923	10'458	19'439	26'957	
5	3'151	6'693	12'441	17'253	
6	2'188	4'648	8'639	11'981	
7	1'607	3'415	6'347	8'802	
8	1'231	2'614	4'860	6'739	
9	972	2'066	3'840	5'325	
10	788	1'673	3'110	4'313	
11	651	1'383	2'570	3'565	
12	547	1'162	2'160	2'995	
13	466	990	1'840	2'552	
14	402	854	1'587	2'201	
15	350	744	1'382	1'917	
16	308	654	1'215	1'685	
17	273	579	1'076	1'492	
18	243	516	960	1'331	
19	218	464	862	1'195	
20	197	418	778	1'078	
21	179	379	705	978	
22	163	346	643	891	
23	149	316	588	815	
24	137	290	540	749	

HUBER+SUHNER AG
Tumbelenstrasse 20
8330 Pfäffikon ZH
Switzerland
Phone +41 44 952 22 11
hubersuhner.com

HUBER+SUHNER is certified according to ISO 9001, ISO 14001, OHSAS 18001, EN(AS) 9100, IATF 16949 and ISO/TS 22163 – IRIS.

Waiver

Fact and figures herein are for information only and do not represent any warranty of any kind.